



# Ενεργειακός σχεδιασμός κτηρίων και αρχιτεκτονική

Γιάννης Ρωμάνος, αρχιτέκτων  
Γραφείο Μελετών Αλέξανδρου Ν. Τομπάζη Α.Ε.

Πανεπιστήμιο Πατρών  
Σεμινάριο Βιοκλιματικού Σχεδιασμού Κτηρίων  
Τετάρτη, 25 Μαΐου 2016

## POLAR CHANGES ARCTIC

By 2080 sea ice is expected to disappear in the summer months

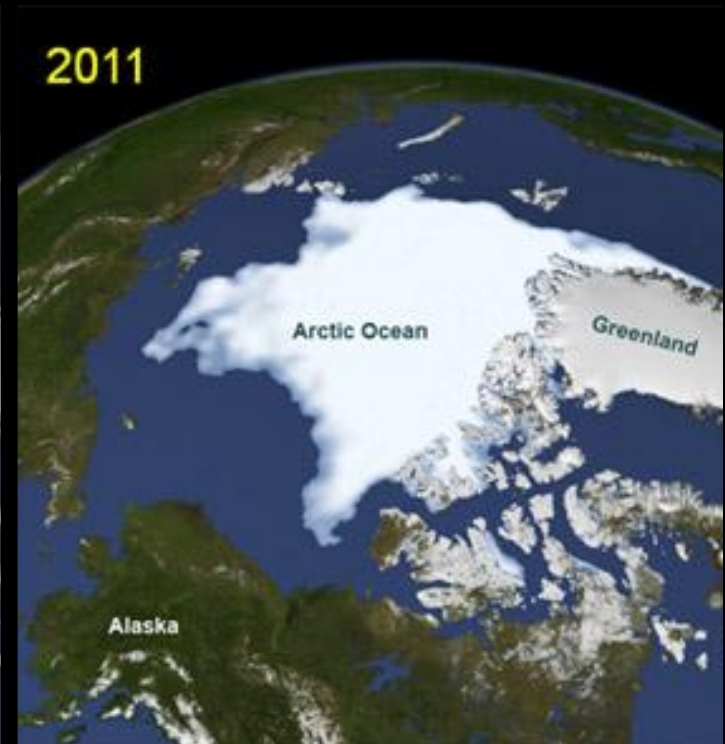

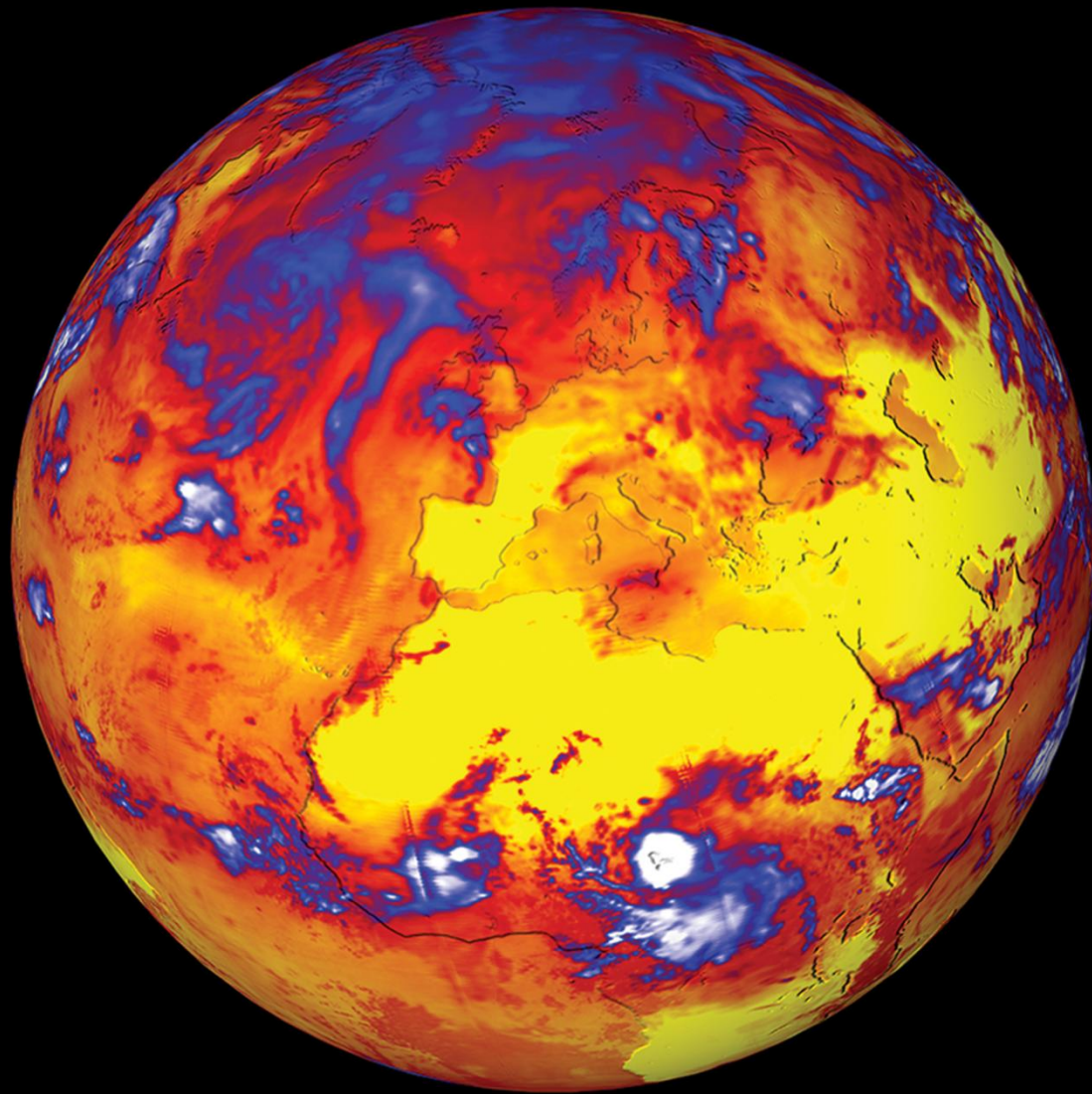

Outgoing Longwave Radiation ( $W/m^2$ )

160 320

Sahara temperatures spread north engulfing Europe in a heat wave in August 2003

Τα κτήρια καταναλώνουν πάνω από το 40% της ενέργειας



Fucushima 2015



Farmer and son plowing strip of land in the shadow of a coke plant. Katowice, Poland  
James P. Blair / National Geographic Image Collection



Νεκρός βρέθηκε ο Σήφης



Το παρελθόν



Υεμένη

Μαθήματα από την Ανώνυμη Αρχιτεκτονική





Το γεφύρι της Πλάκας

Η Ανώνυμη Αρχιτεκτονική έχει να κάνει με το να επιτυγχάνεις το μέγιστο με τα ελάχιστα μέσα

The work of the Olgay brothers

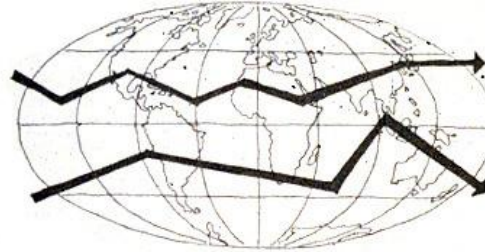

## DESIGN WITH CLIMATE

BIOCLIMATIC APPROACH TO ARCHITECTURAL REGIONALISM

VICTOR OLGAY

some chapters based on cooperative  
research with ALADAR OLGAY

PRINCETON UNIVERSITY PRESS  
PRINCETON, NEW JERSEY, 1963

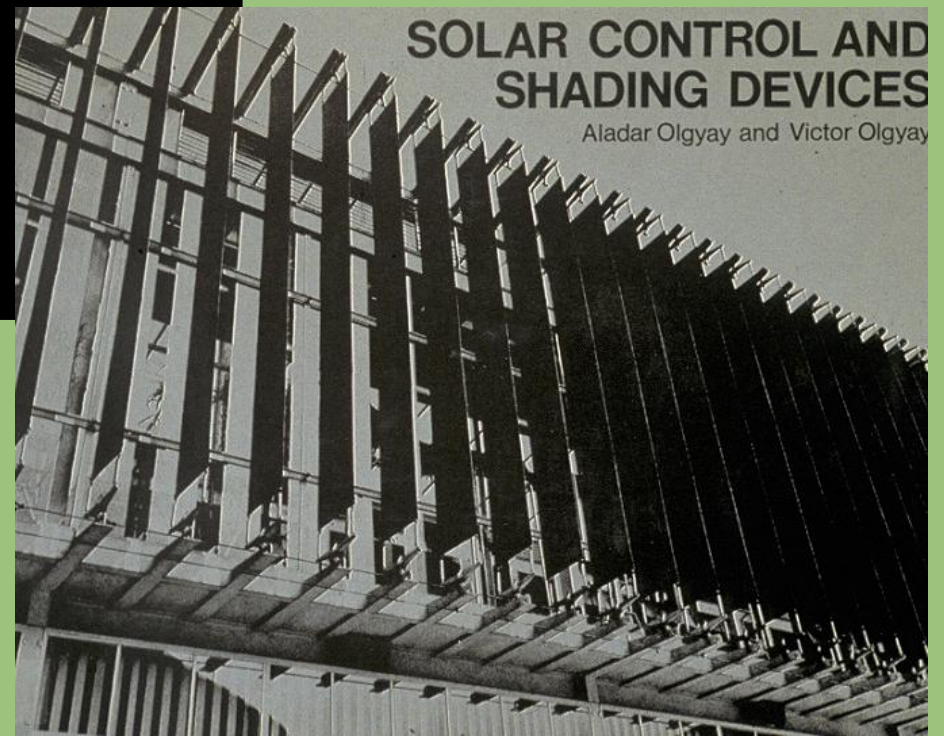

Οι πρωτοπόροι



ΗΛΙΑΚΗ ΑΡΧΙΤΕΚΤΟΝΙΚΗ  
αλήθεια τί σημαίνει;

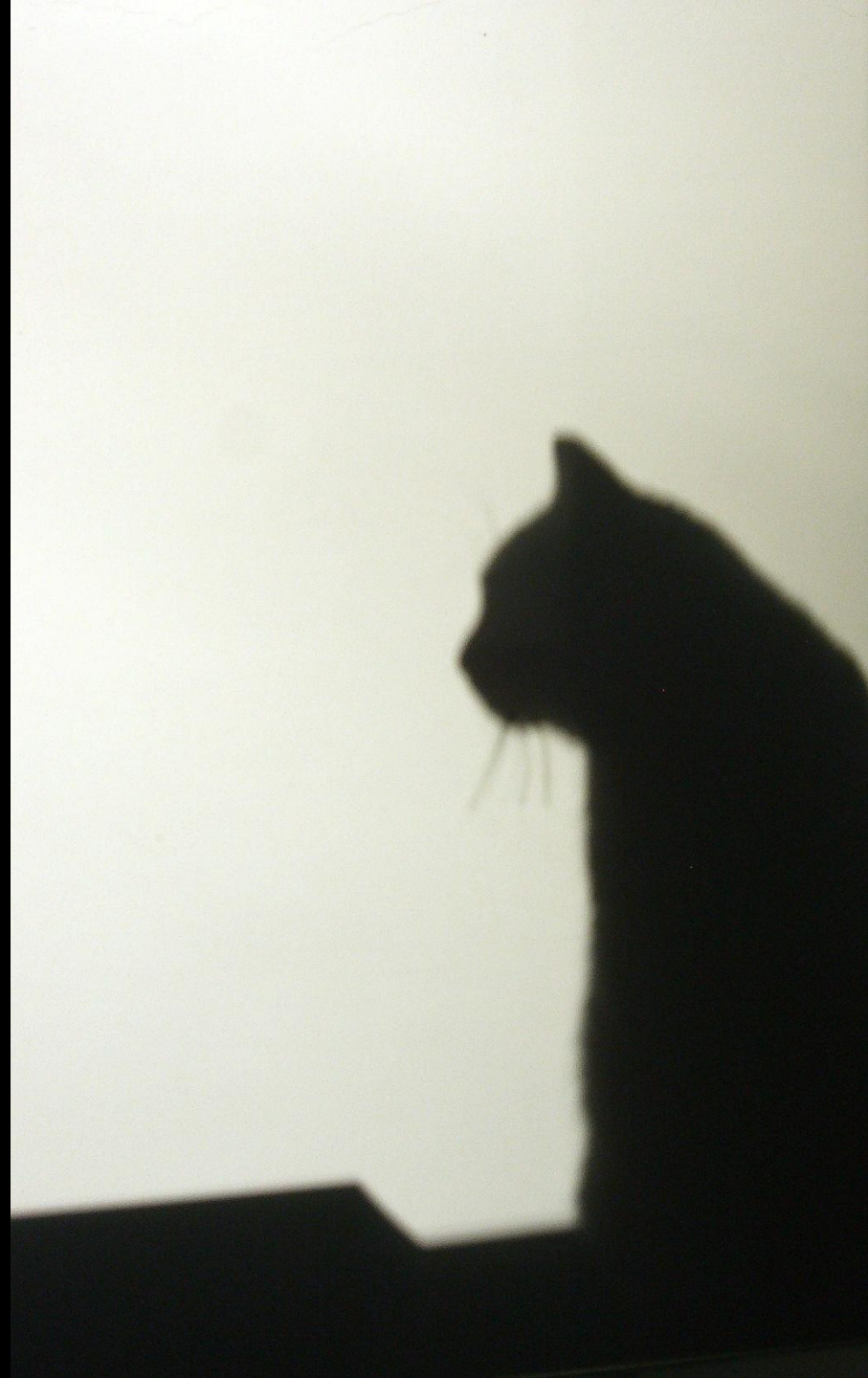

Observatory Tantas Mantar 1724-27, Delhi, Tai Singh 4/86



Όλα τα κτήρια είναι ηλιακά

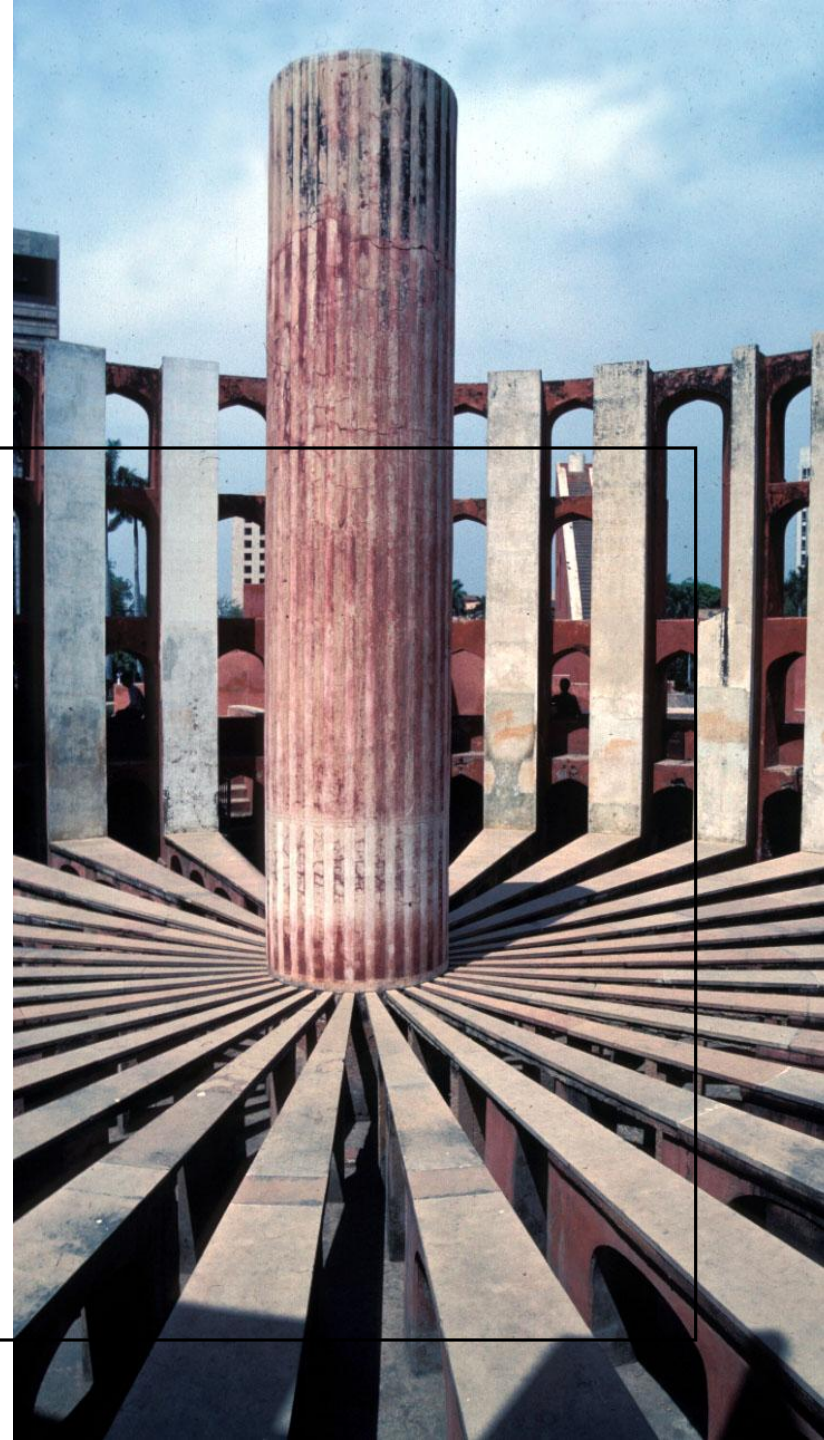

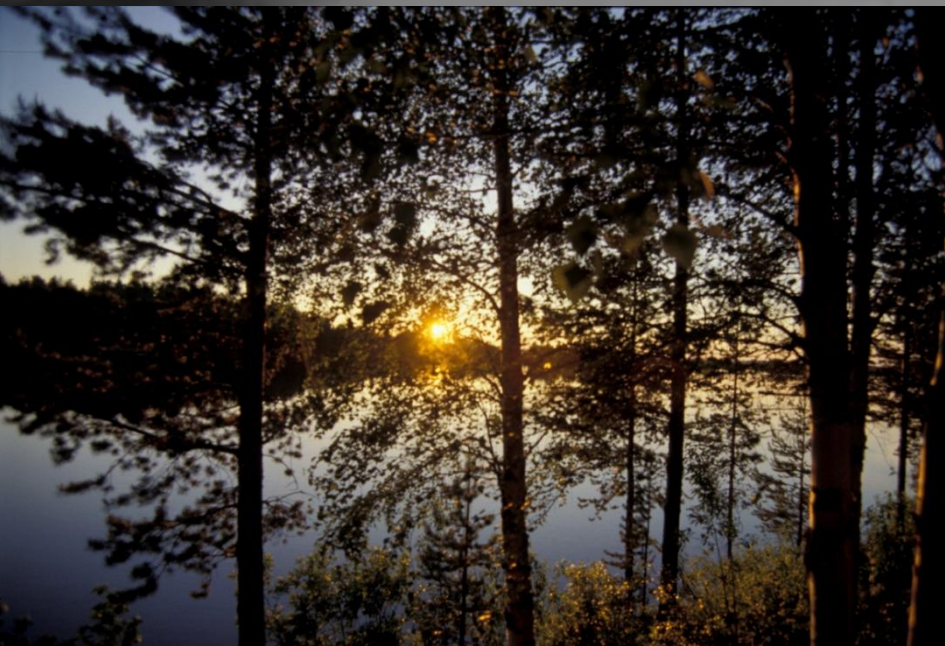

Ήλιος μεσάνυχτων, Rovaniemi 6/98



Ανατολή, Τράπεζα Αιγιαλείας 8/95

# Ηλιακή ενέργεια και Εποχές



Spring, Finland



Summer, Finland



Autumn, Finland



Winter, Finland



‘Ηλιος 1’ Ενεργητική Ηλιακή Εξοχική κατοικία  
Τράπεζα Αιγιαλείας (1977)



**Ενεργητικά Συστήματα**  
πλεονεκτήματα - μειονεκτήματα



‘Ηλιακό Χωριό Λυκόβρυση, Αθήνα (1979)



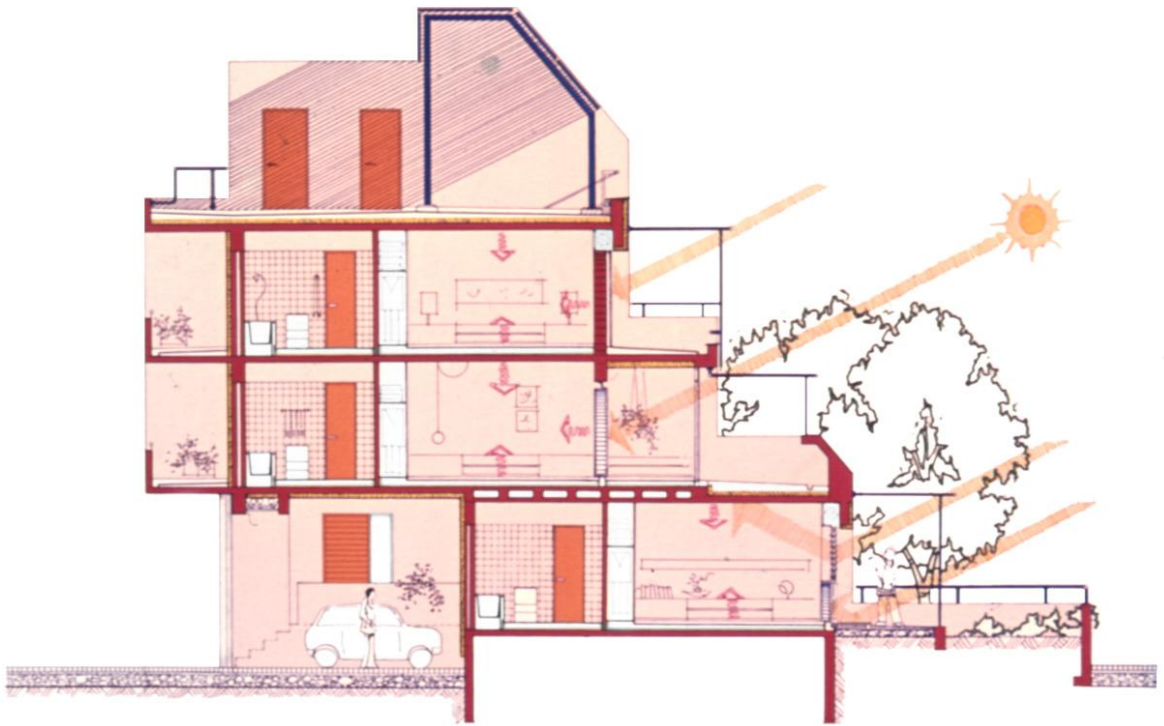

‘Ηλιακό Χωριό, Λυκόβρυση  
Αθήνα (1979)



Το παρόν

Fuel cakes, India cowdung, Aurangebada - Ajanta



Από τα θέματα ενέργειας σε γενικότερους προβληματισμούς



Favelas, Píó, Βραζιλία 9/93



Slums, Walled City of Kowloon, Har Nam, Κίνα

# Ατμοσφαιρική ρύπανση



Αθήνα



Κάιρο

# ΒΙΟΚΛΙΜΑΤΙΚΗ ΑΡΧΙΤΕΚΤΟΝΙΚΗ



# ΟΙ 10 ΕΝΤΟΛΕΣ ΤΟΥ ΒΙΟΚΛΙΜΑΤΙΚΟΥ ΣΧΕΔΙΑΣΜΟΥ

- 1 ΑΝΑΛΥΣΗ ΚΛΙΜΑΤΙΚΩΝ ΔΕΔΟΜΕΝΩΝ
- 2 ΠΡΟΣΑΝΑΤΟΛΙΣΜΟΣ – ΤΟΠΟΓΡΑΦΙΑ
- 3 ΚΕΛΥΦΟΣ ΤΟΥ ΚΤΗΡΙΟΥ – ΜΕΙΩΣΗ ΕΝΕΡΓΕΙΑΚΩΝ ΑΠΑΙΤΗΣΕΩΝ
- 4 ΕΠΙΘΥΜΗΤΑ ΗΛΙΑΚΑ ΚΕΡΔΗ – ΘΕΡΜΑΝΣΗ
- 5 ΑΝΕΠΙΘΥΜΗΤΑ ΗΛΙΑΚΑ ΚΕΡΔΗ – ΣΚΙΑΣΗ ΚΑΙ ΔΡΟΣΙΣΜΟΣ
- 6 ΦΥΣΙΚΟΣ ΑΕΡΙΣΜΟΣ – ΗΜΕΡΗΣΙΟΣ / ΝΥΚΤΕΡΙΝΟΣ
- 7 ΦΥΣΙΚΟΣ ΦΩΤΙΣΜΟΣ
- 8 ΠΕΡΙΒΑΛΛΩΝ ΧΩΡΟΣ – ΦΥΤΕΥΣΗ – ΜΙΚΡΟΚΛΙΜΑ
- 9 ΥΛΙΚΑ – ΑΝΑΚΥΚΛΩΣΗ – ΑΝΑΝΕΩΣΙΜΟΤΗΤΑ
- 10 ΕΞΟΙΚΟΝΟΜΗΣΗ ΦΥΣΙΚΩΝ ΠΟΡΩΝ

# 1 ΑΝΑΛΥΣΗ ΚΛΙΜΑΤΙΚΩΝ ΔΕΔΟΜΕΝΩΝ

By overlaying this passive conditioning outlook on the temperature and humidity displacements for Athens in 1977, one sees that most passive strategies for heating and cooling (if completely designed) can meet the average conditioning loads.

Several assumptions have been incorporated, including

- 1) Passive solar heating potentials assume clear sky with a southern glass area equal to 1/5 the floor area and a 33% efficiency in solar collection, storage and distribution.
- 2) Natural ventilation relies on 1.5 m/sec (3mph) wind speeds with very open construction, and greater than 3 m/sec (6mph) wind speeds through energy conserving construction.
- 3) Evaporative cooling assumes the ability to add equivalent grams of water.

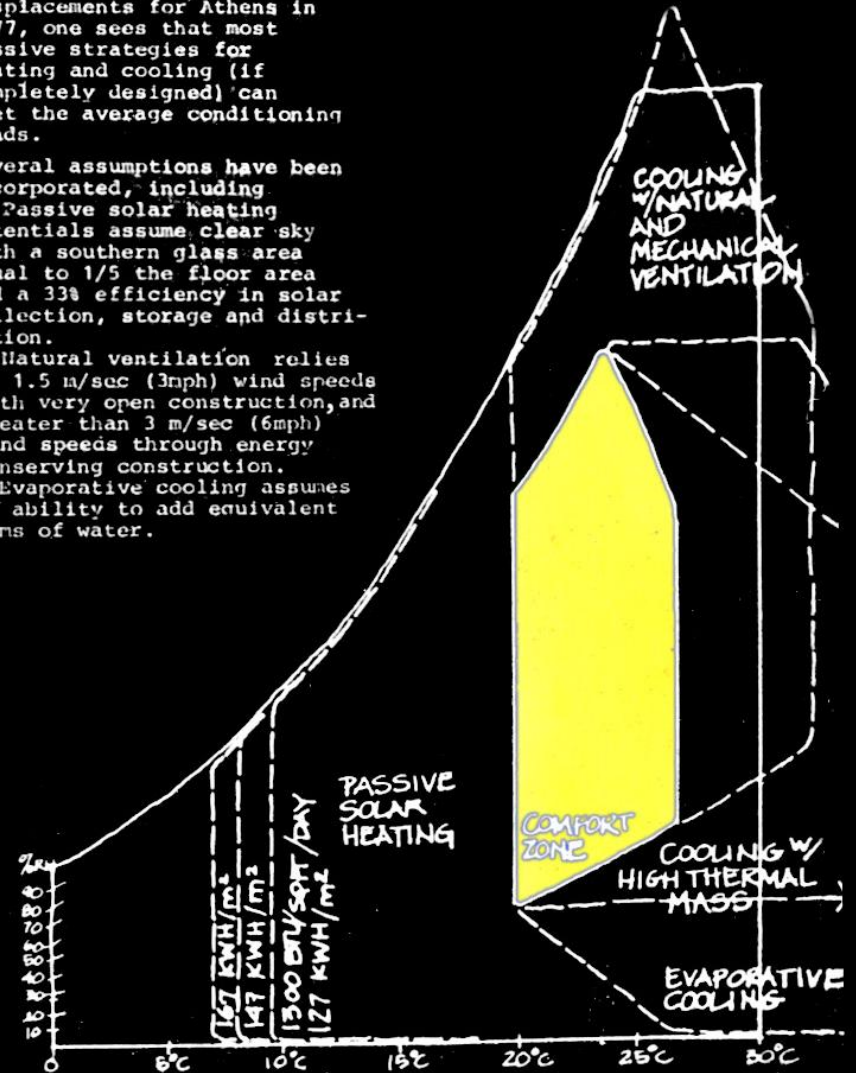

EXPANDED COMFORT ZONES ON PSYCHROMETRIC CHART AS PER GIVONI/MILNE/WATSON

SV 3 PROJECT  
Athens, Greece, July 1980  
INTERATOM





Sulawezi, Ινδονησία 7/83



Μύκονος

## 2 ΠΡΟΣΑΝΑΤΟΛΙΣΜΟΣ - ΤΟΠΟΓΡΑΦΙΑ



# ΘΕΡΜΙΚΕΣ ΖΩΝΕΣ

ΚΑΤΟΨΗ ΠΟΛΥΚΑΤΟΙΚΙΑΣ  
Ηλιακό Χωριό 3, Λυκόβρυση

ΒΟΡΡΑΣ

ΝΟΤΟΣ



προσαρμογή στη φυσική τοπογραφία και τις κλίσεις του εδάφους

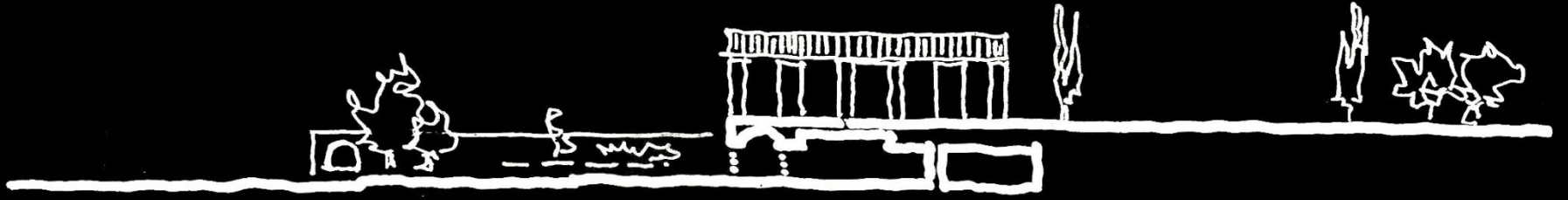

# 3 ΤΟ ΚΕΛΥΦΟΣ ΤΟΥ ΚΤΗΡΙΟΥ ΚΑΙ Η ΜΕΙΩΣΗ ΤΩΝ ΕΝΕΡΓΕΙΑΚΩΝ ΑΠΑΙΤΗΣΕΩΝ

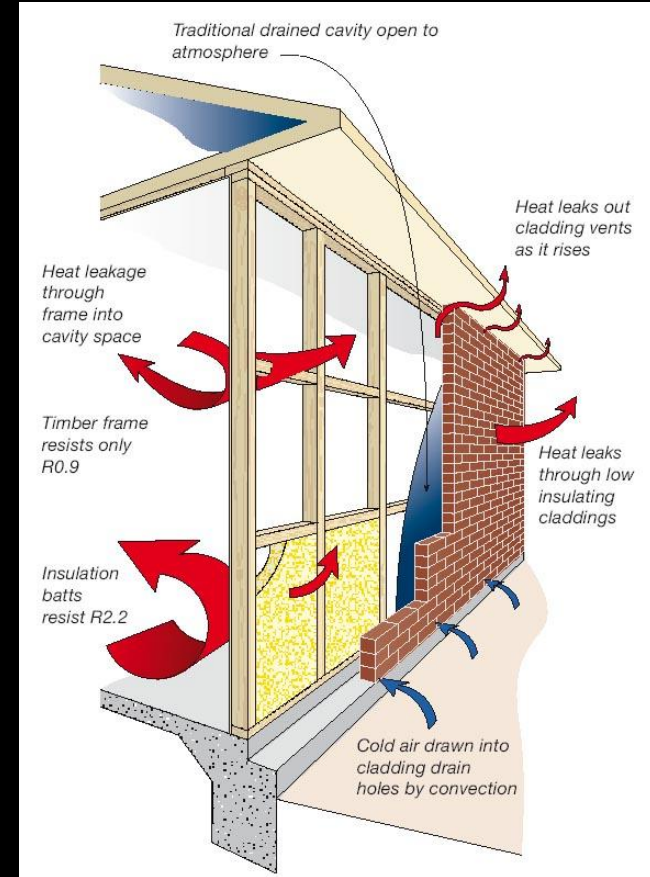
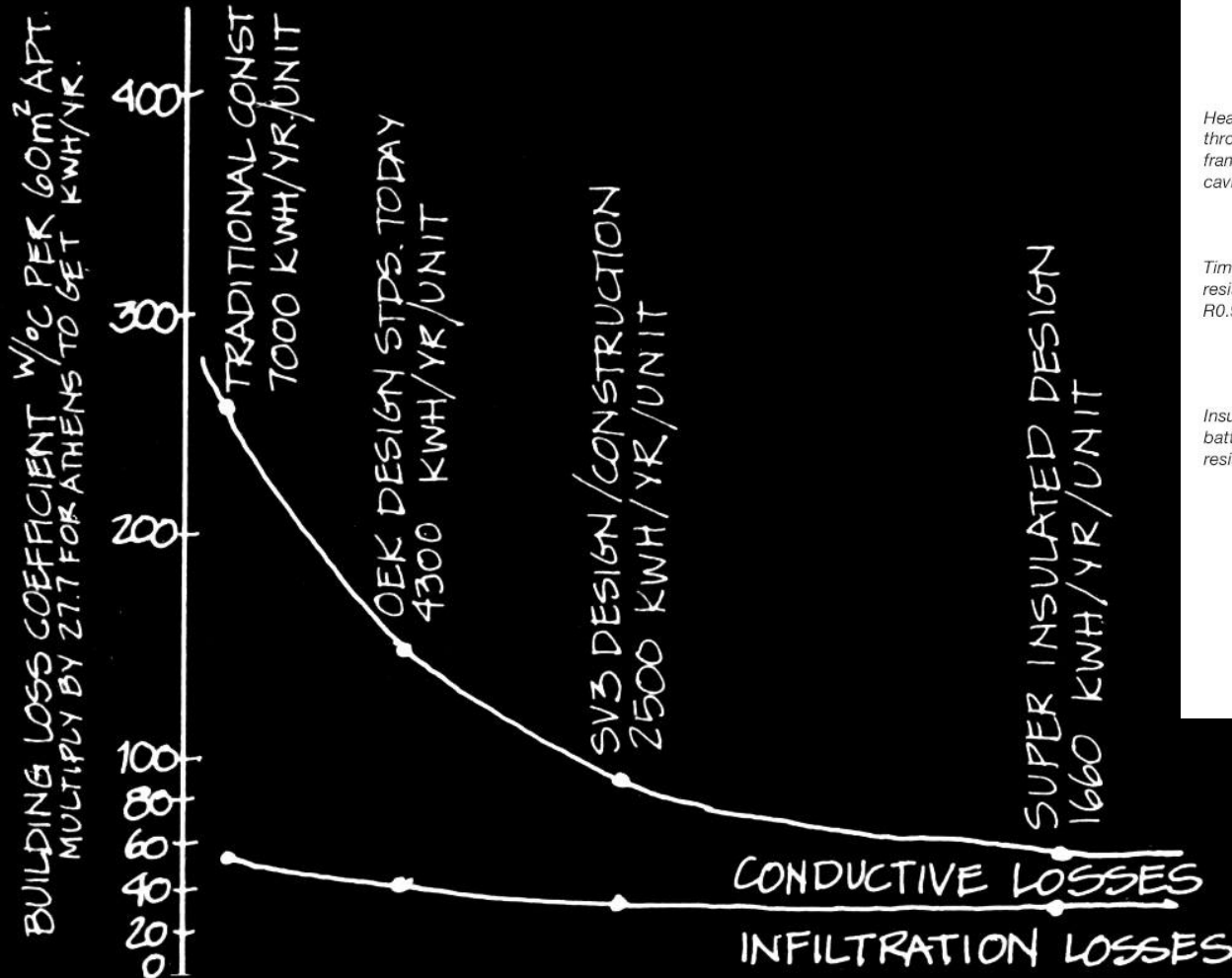

Γραφεία ΑΓΕΤ, Λυκόβρυση (1972)



Πολιτιστικό Κέντρο Λυρική Σκηνή,  
Ίδρυμα Σταύρος Νιάρχος (2015)

# ΑΝΑΛΟΓΙΕΣ ΚΤΗΡΙΑΚΟΥ ΟΓΚΟΥ

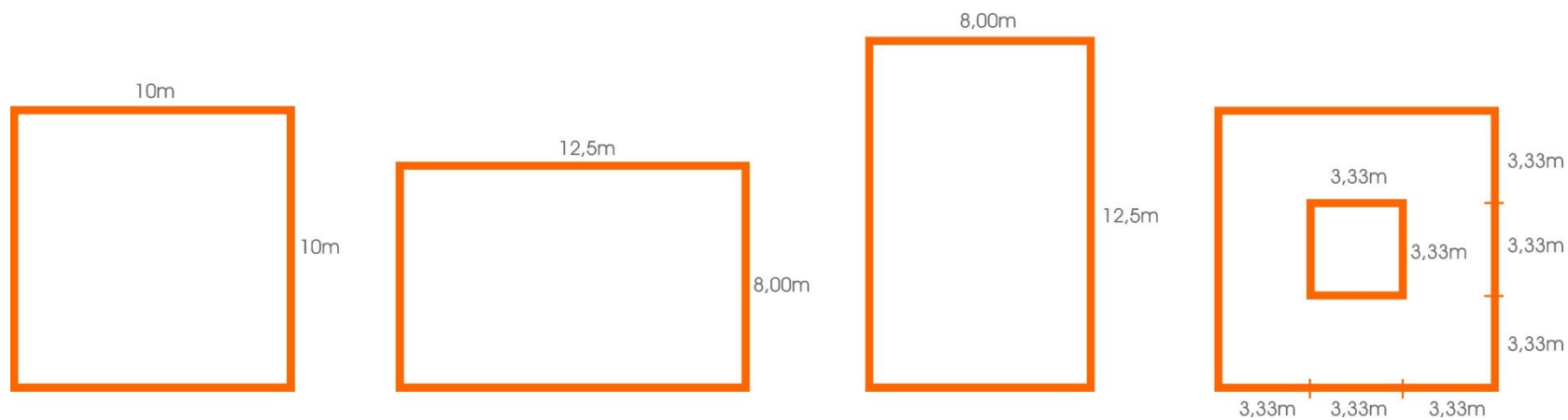

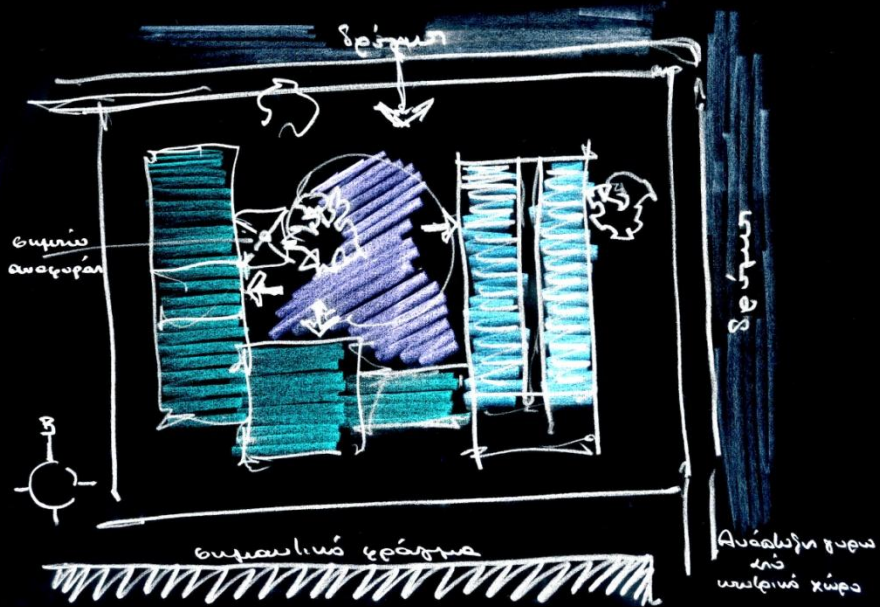



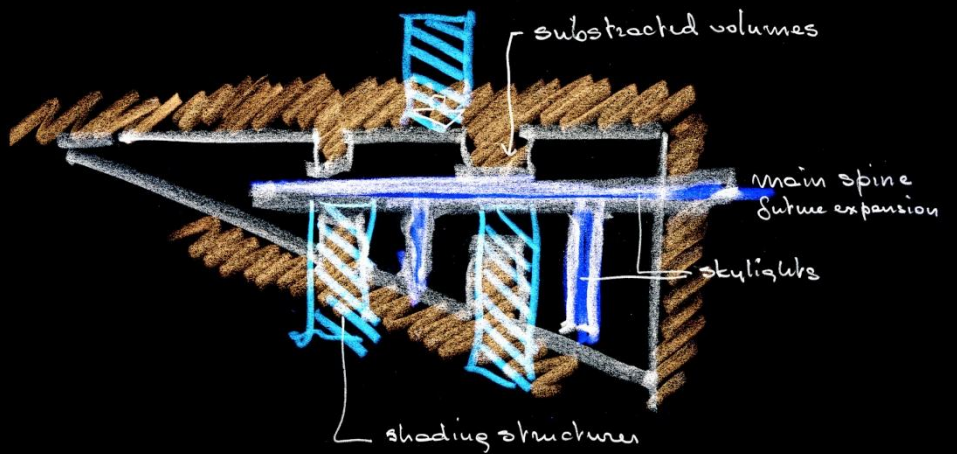

Ελληνικά Πετρέλαια Α.Ε., Κτίριο Γραφείων Κεντρικής Διοίκησης, Ασπρόπυργος Αττικής (1994)

# Μονώσεις

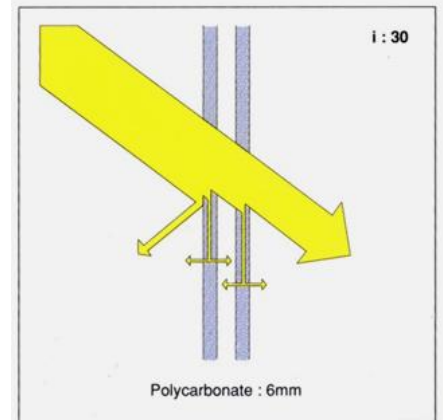
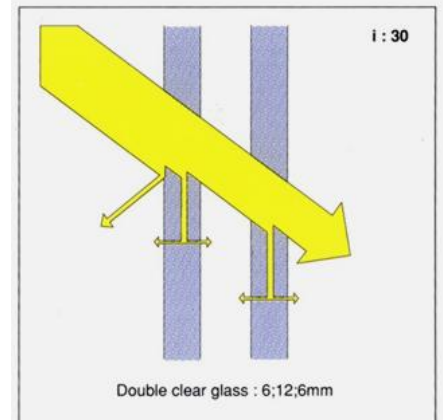
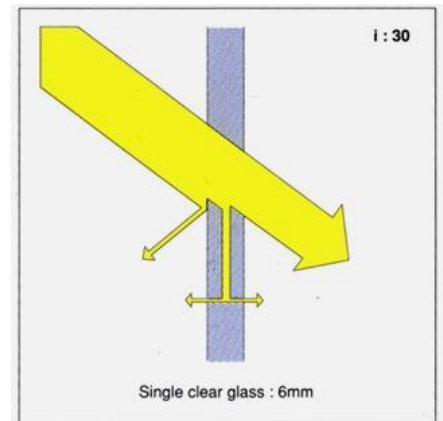

## 4 ΕΠΙΘΥΜΗΤΑ ΗΛΙΑΚΑ ΚΕΡΔΗ - ΘΕΡΜΑΝΣΗ



# Το κτήριο

## Στρατηγικές θέρμανσης

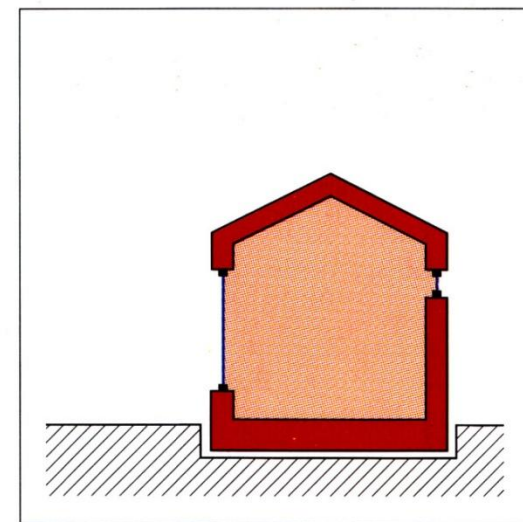
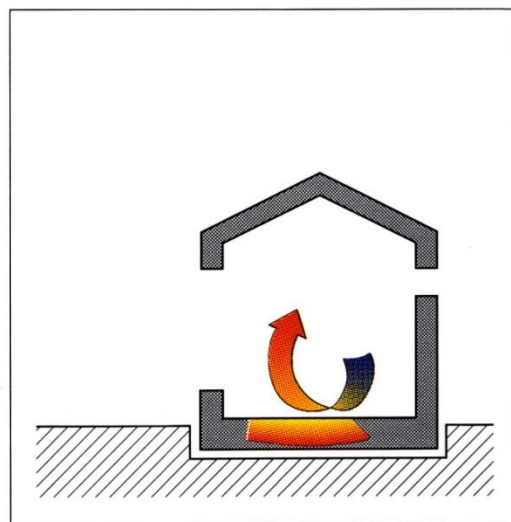
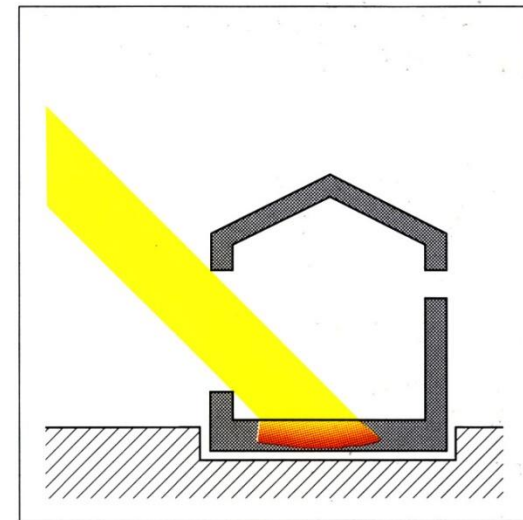
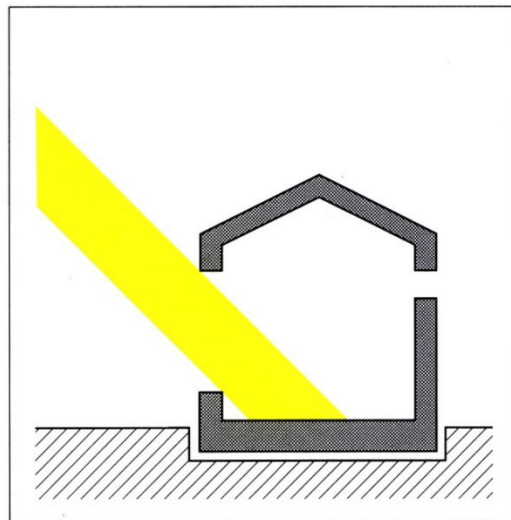

# Το κτήριο

## Στρατηγικές θέρμανσης



**Συλλογή**

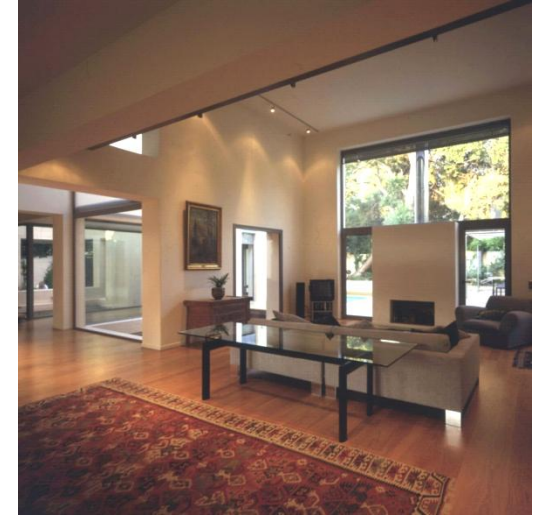

**Αποθήκευση**

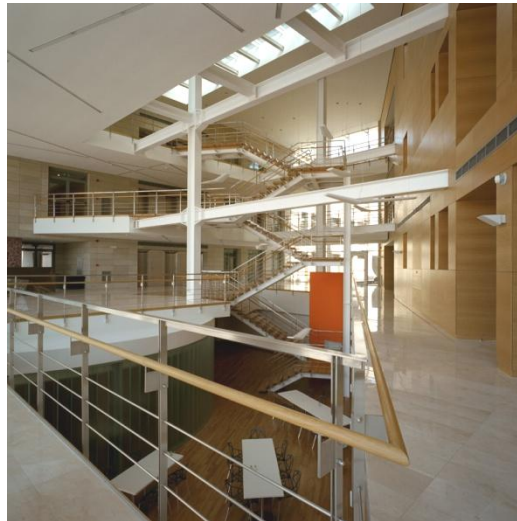

**Διανομή**



**Απώλειες**

# Αποθήκευση θερμότητας άμεση

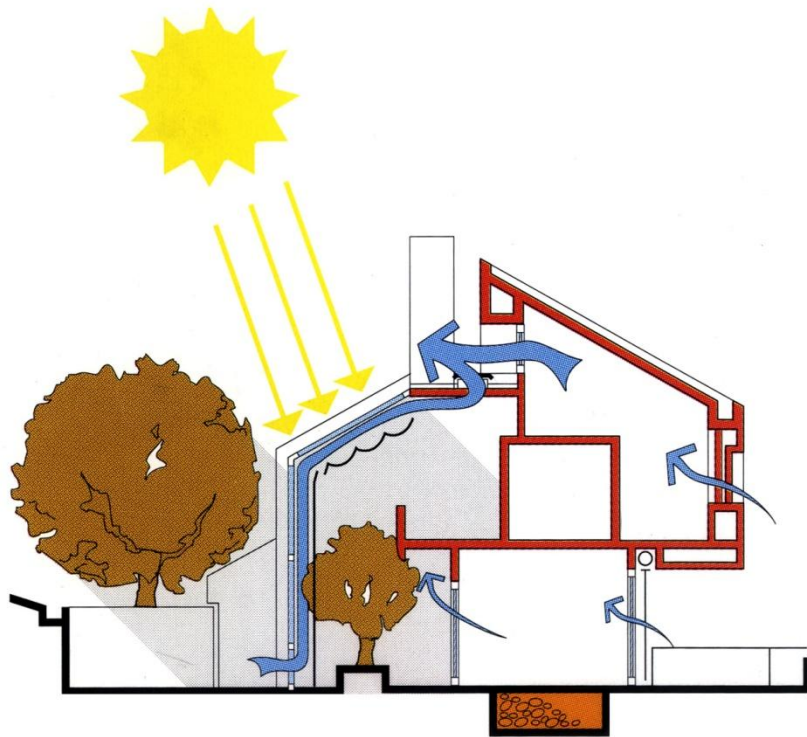

# Αποθήκευση θερμότητας έμμεση

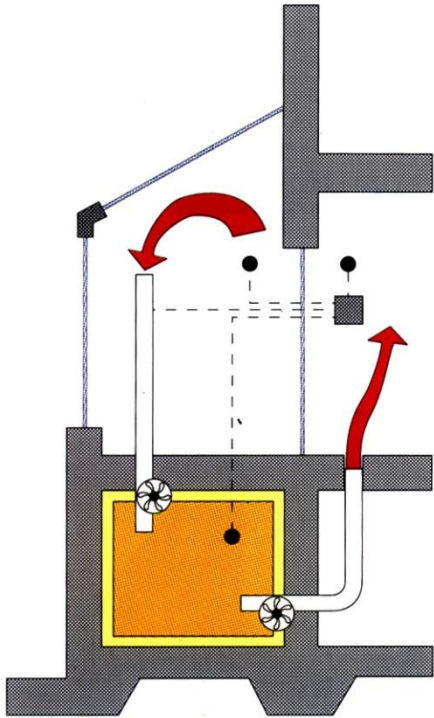

# 5 ΑΝΕΠΙΘΥΜΗΤΑ ΗΛΙΑΚΑ ΚΕΡΔΗ - ΣΚΙΑΣΗ ΚΑΙ ΔΡΟΣΙΣΜΟΣ









Asea Brown Boveri (ABB) Γραφεία, Μεταμόρφωση  
Αθήνα (1995)

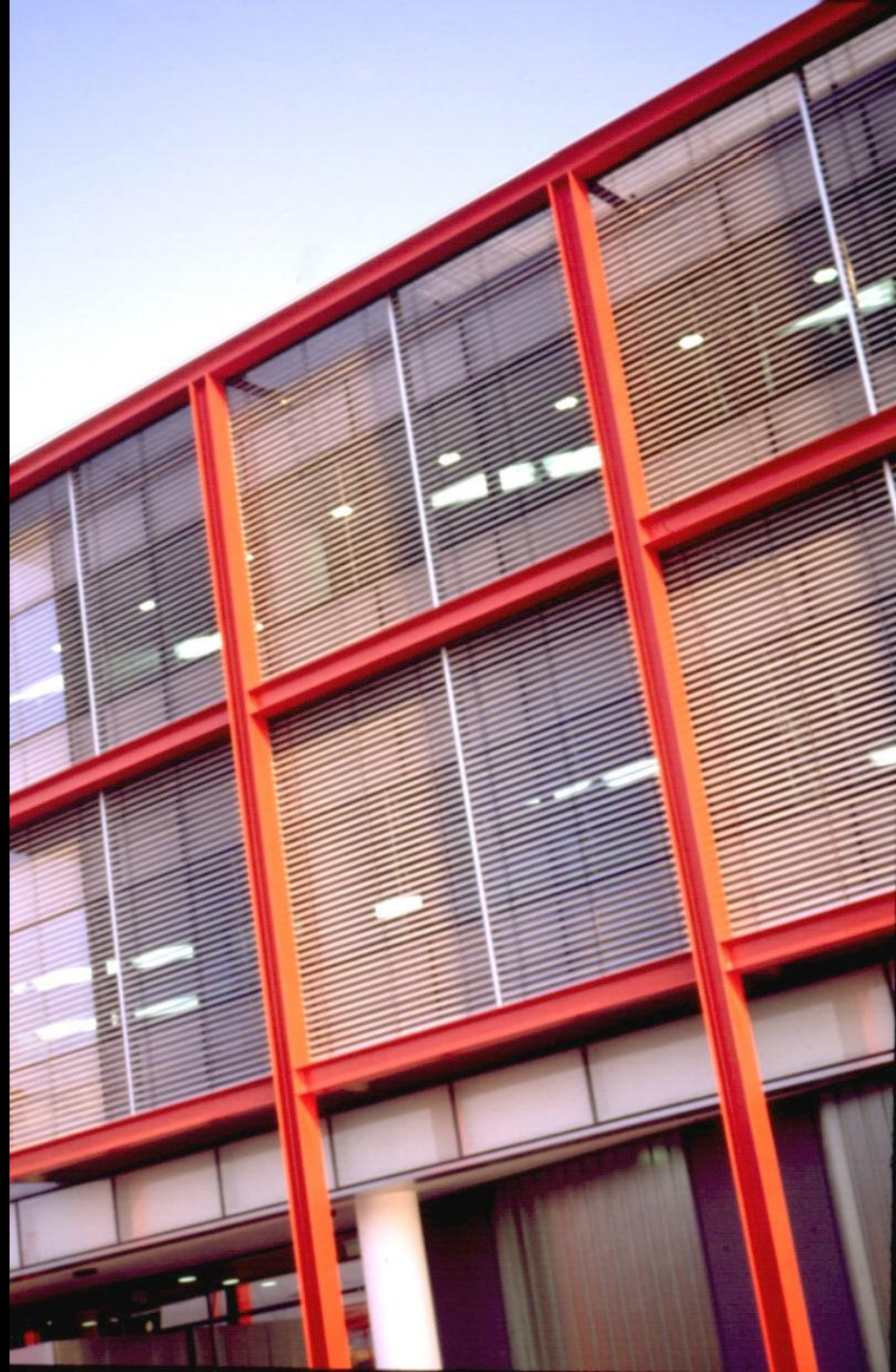

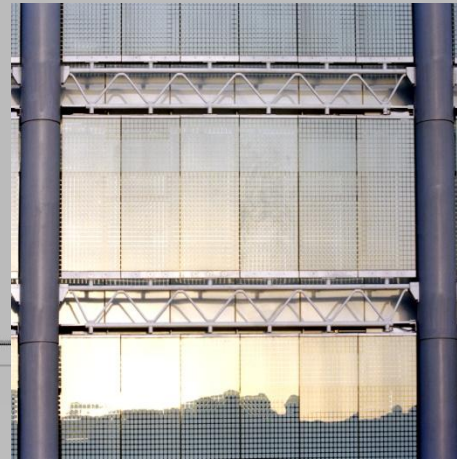
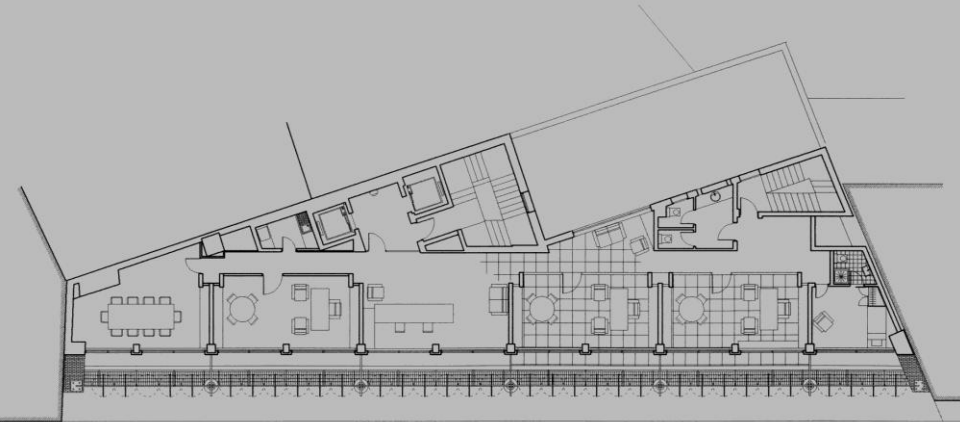
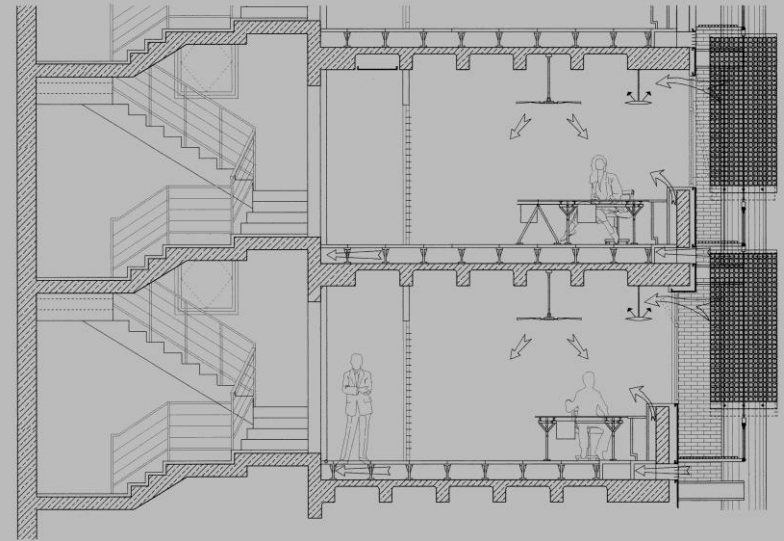

## 6 ΦΥΣΙΚΟΣ ΑΕΡΙΣΜΟΣ - ΗΜΕΡΗΣΙΟΣ / ΝΥΚΤΕΡΙΝΟΣ



Υδρα 3/04



Σπέτσες 8/93

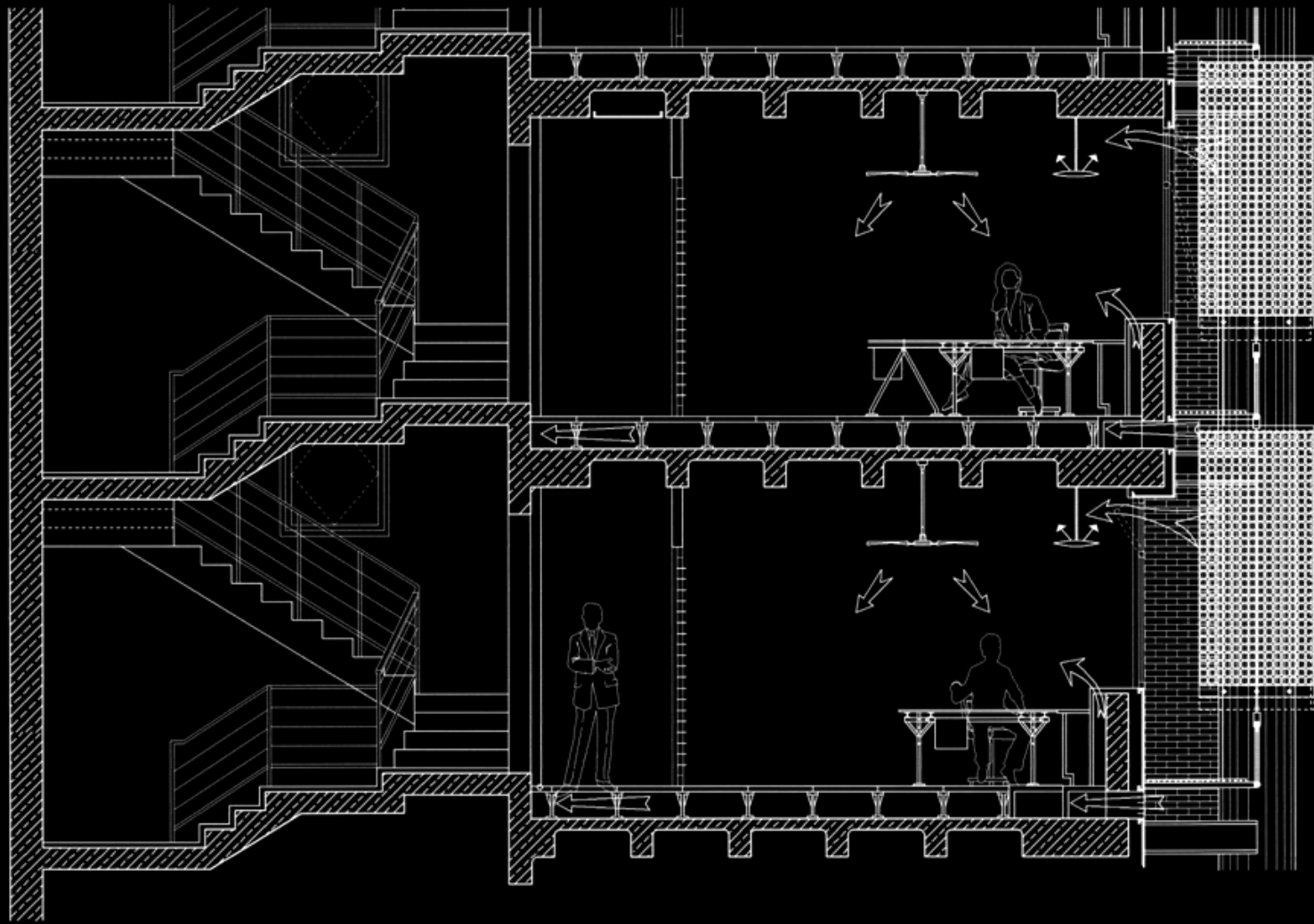

ΑΒΑΞ, αθήνα





## Bioclimatic function of atrium

stack effect



cross ventilation

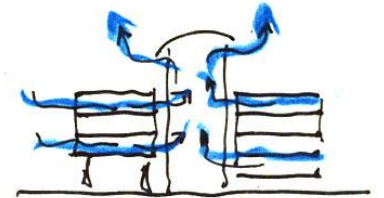

shading

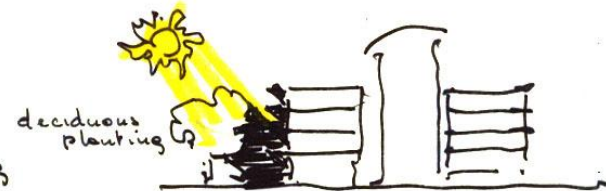

night ventilation

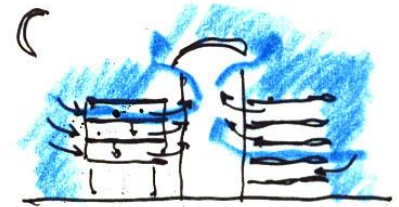

water evaporation

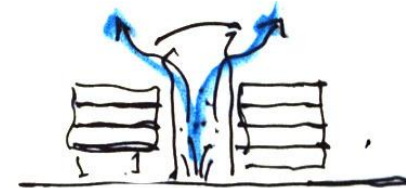

## 7 ΦΥΣΙΚΟΣ ΦΩΤΙΣΜΟΣ



Πάνθεον, Ρώμη 3/94



Υερίνη



Κτήριο γραφείων, Πολύδροσο





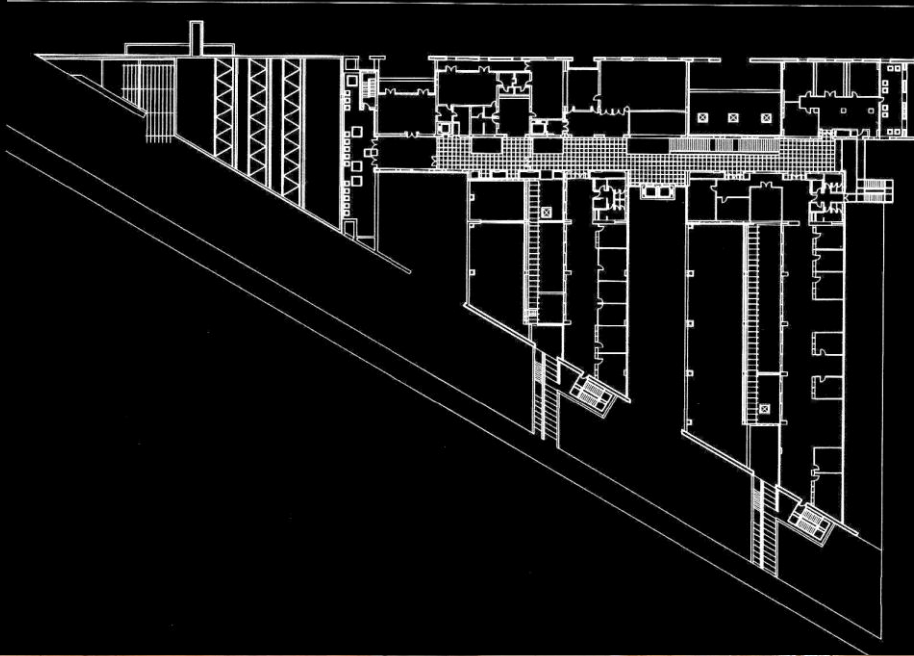

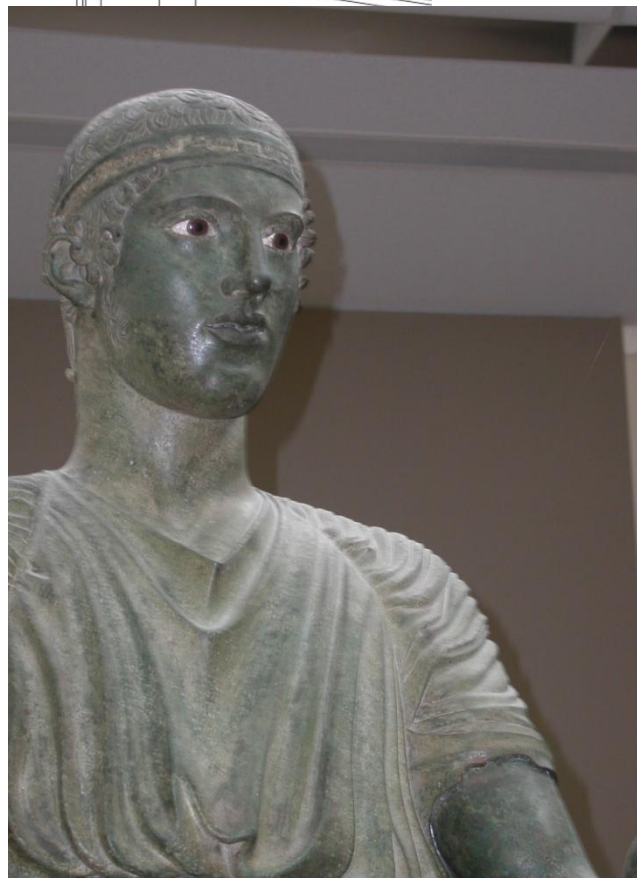
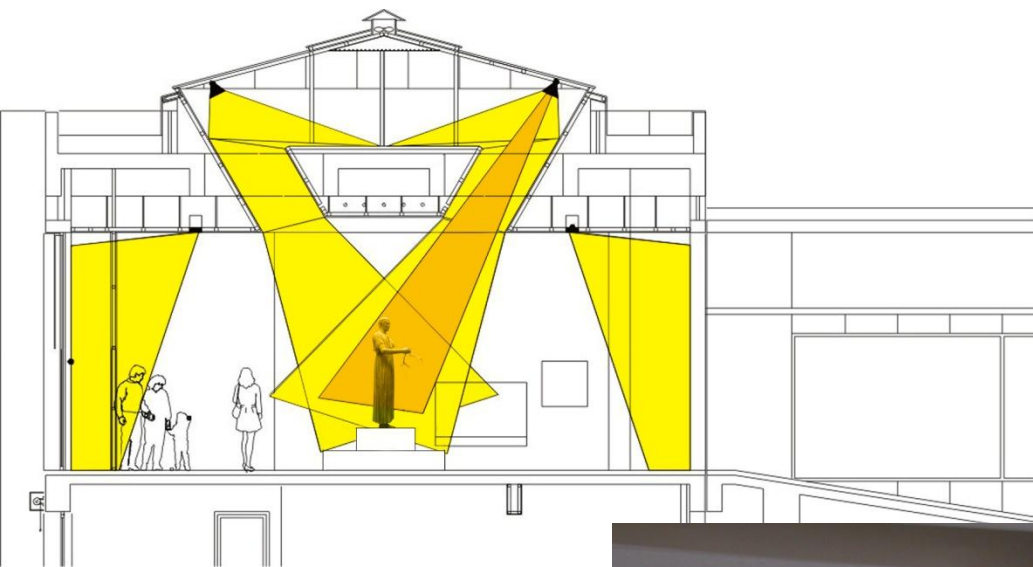

Ηνίοχος , Μουσείο Δελφών



16:40h

25/01/08

## 8 ΠΕΡΙΒΑΛΛΩΝ ΧΩΡΟΣ – ΦΥΤΕΥΣΗ / ΜΙΚΡΟΚΛΙΜΑ



Τράπεζα



Shaded walk - way, Expro Σεβίλλη 1992



Outdoors, Expro Σεβίλλη



**Andros, Greece**



Κτήριο Γραφείων της εταιρείας Καλυφτάκι Α.Ε.  
Κάτω Κηφισιά, Αθήνα

# 9 ΥΛΙΚΑ / ΑΝΑΚΥΚΛΩΣΗ / ΑΝΑΝΕΩΣΙΜΟΤΗΤΑ

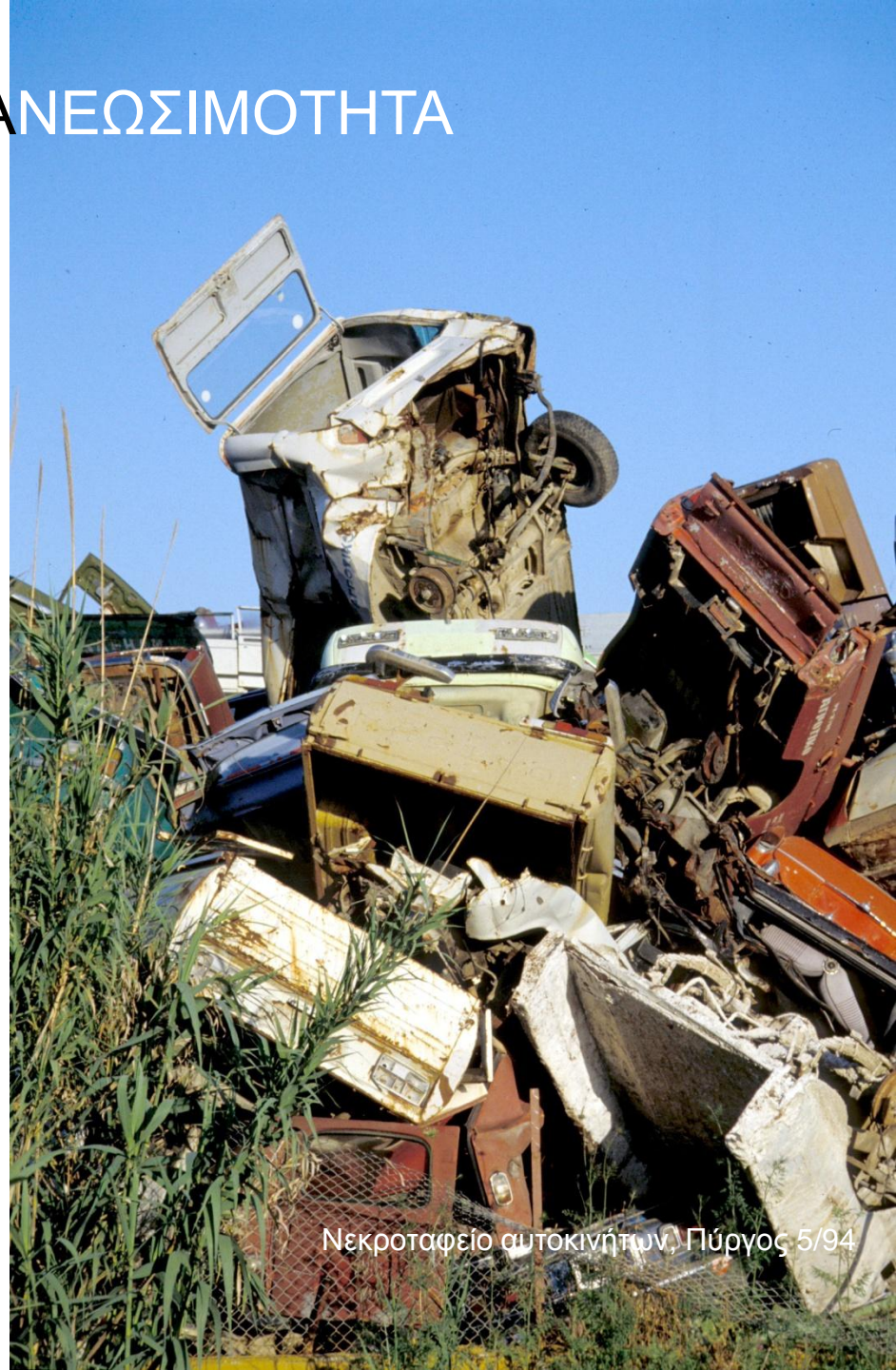

Νεκροταφείο αυτοκινήτων, Πύργος 5/94



# 10 ΕΞΟΙΚΟΝΟΜΗΣΗ ΦΥΣΙΚΩΝ ΠΟΡΩΝ



# ΧΡΗΣΗ ΑΝΑΝΕΩΣΙΜΩΝ ΠΗΓΩΝ ΕΝΕΡΓΕΙΑΣ





Sandia Laboratories, Albuquerque, U.S.A.



Κτήριο Γραφείων για την ΑΒΑΞ Α.Ε., Αθήνα





Παραδείγματα έργων  
**Γραφείου Μελετών Α. Ν. Τομπάζη**



**‘Ξενία’ Συγκρότημα 17 Κατοικιών  
Κεφαλάρι, Κηφισιά (1992)**



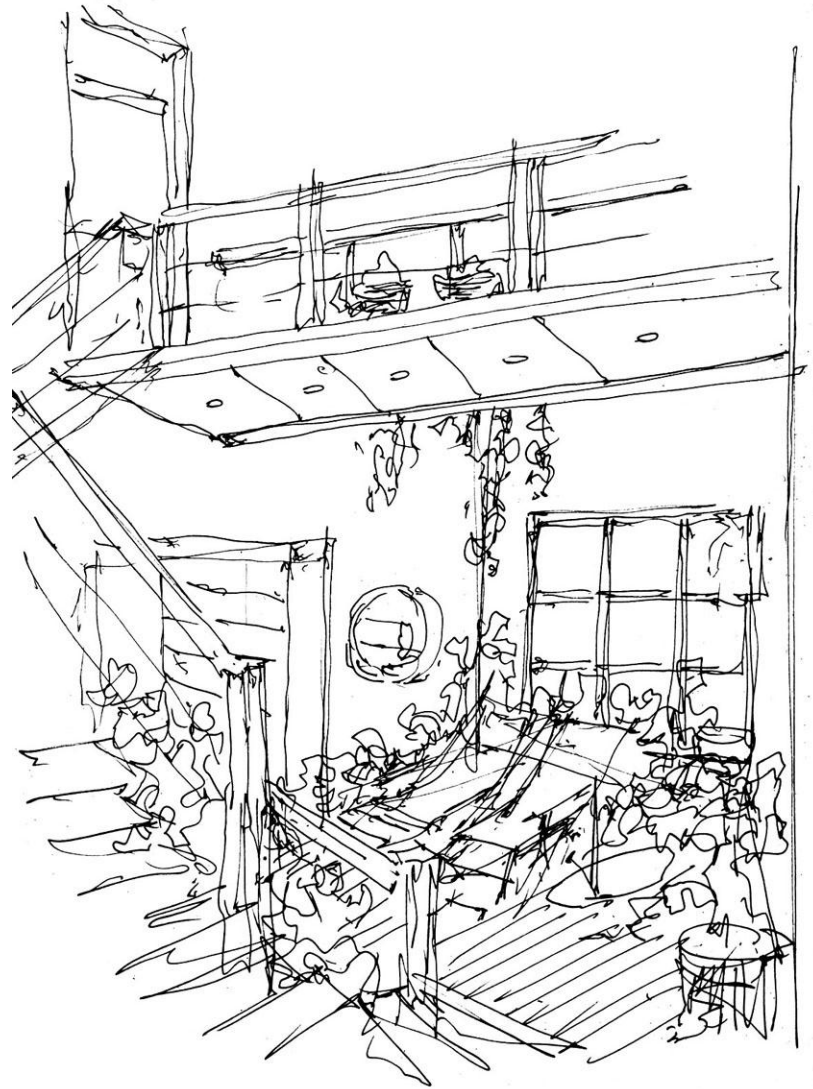



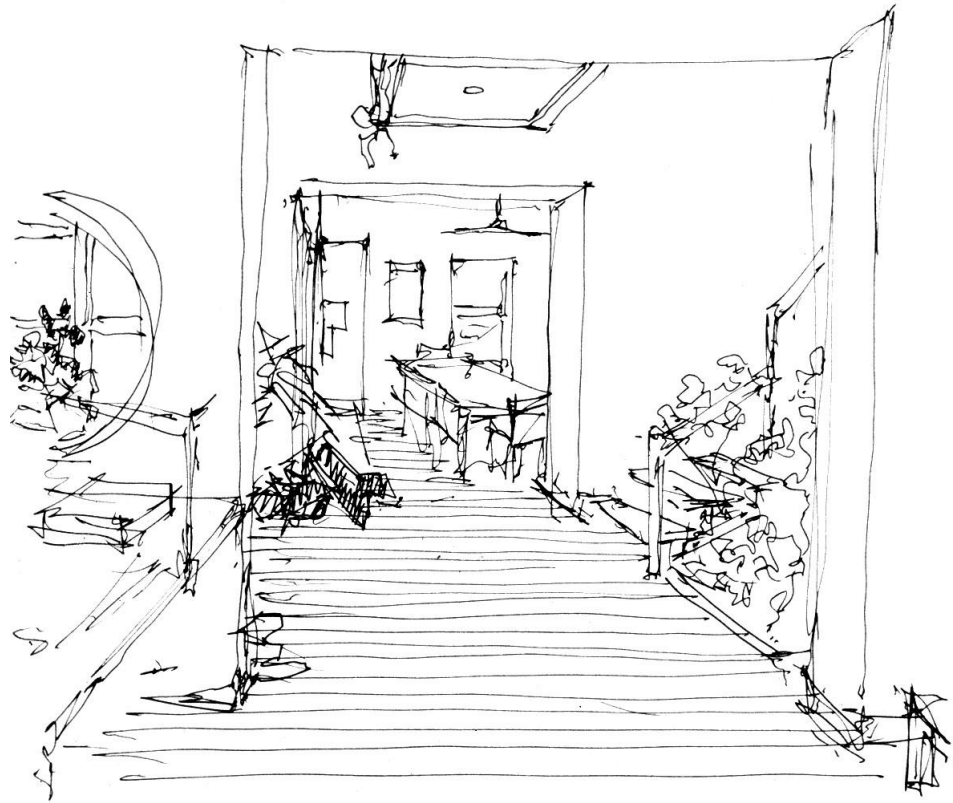

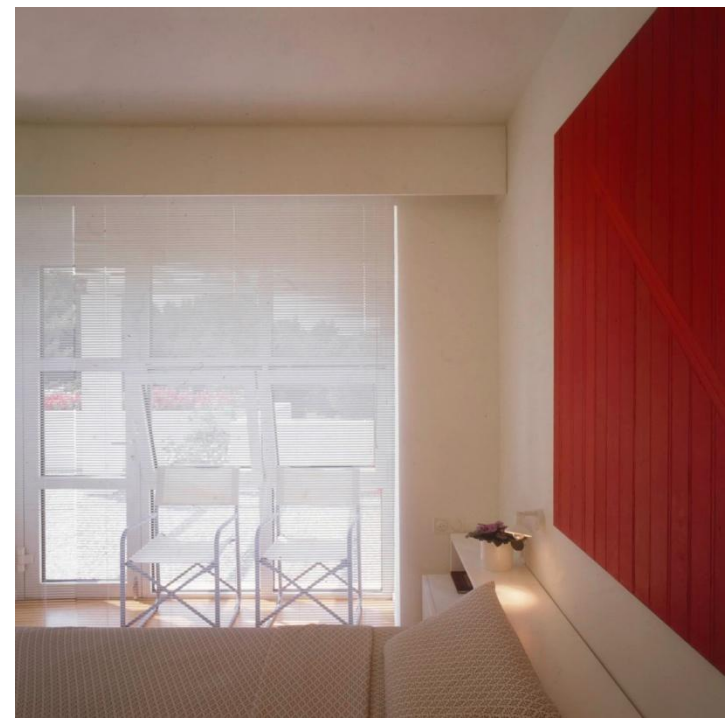



**Κτήριο γραφείων και κατάστημα Alpha Bank, Αθήνα (2008)**



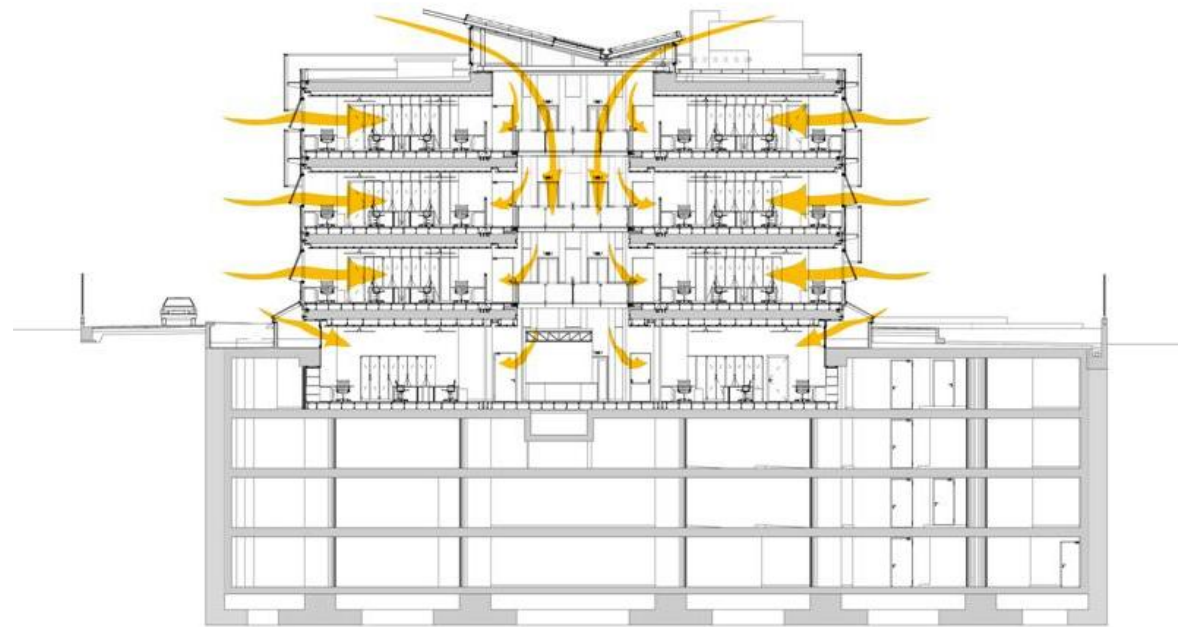

ΦΥΣΙΚΟΣ ΦΩΤΙΣΜΟΣ

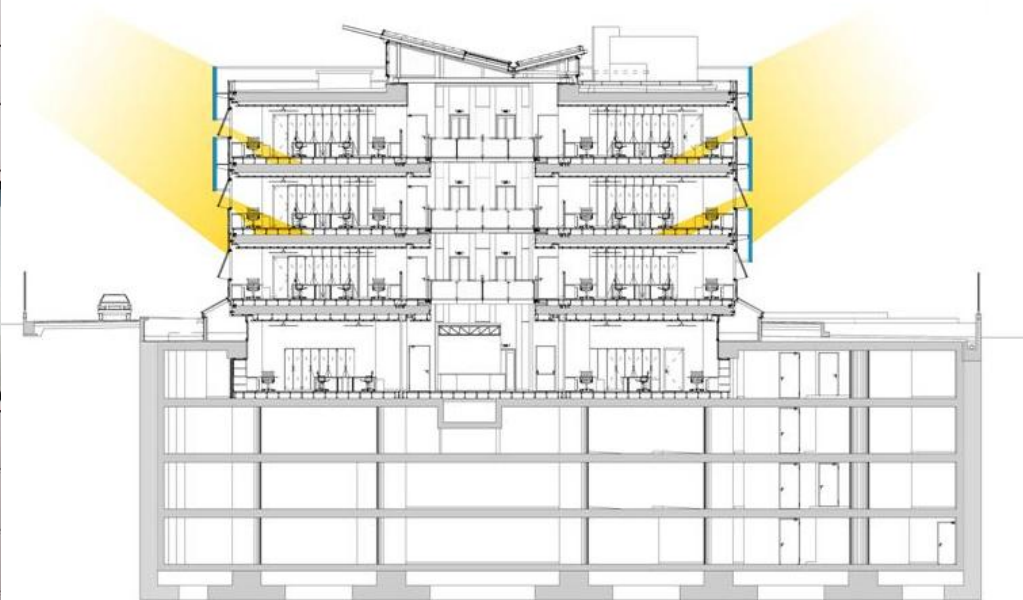

ΣΚΙΑΣΗ

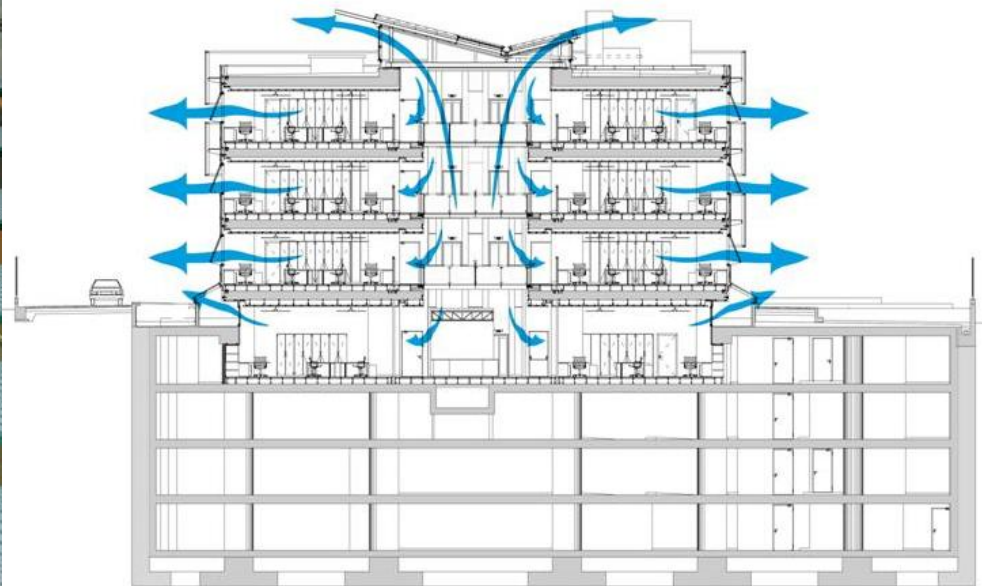

ΔΙΑΜΠΕΡΗΣ ΑΕΡΙΣΜΟΣ

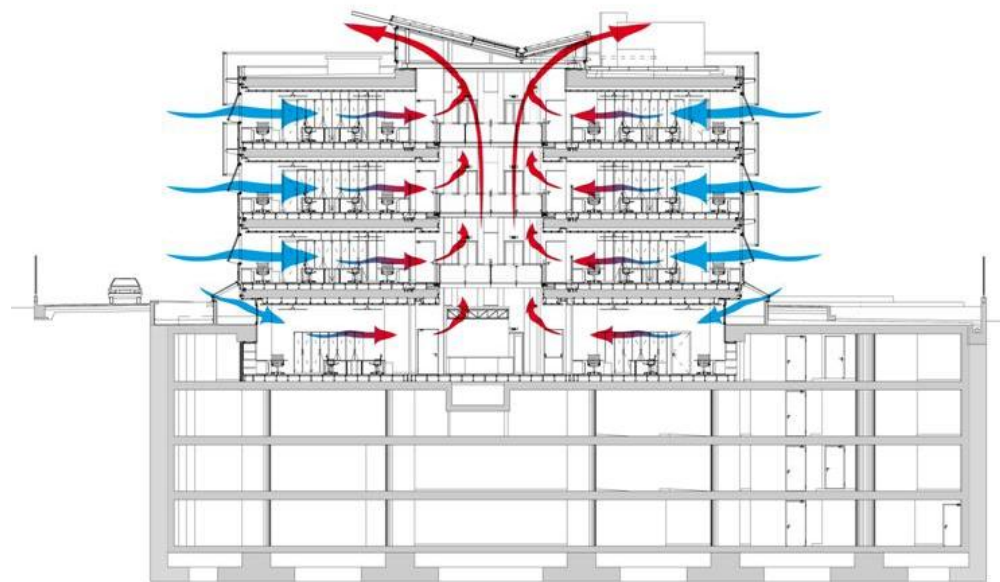

ΝΥΚΤΕΡΙΝΟΣ ΕΞΑΕΡΙΣΜΟΣ



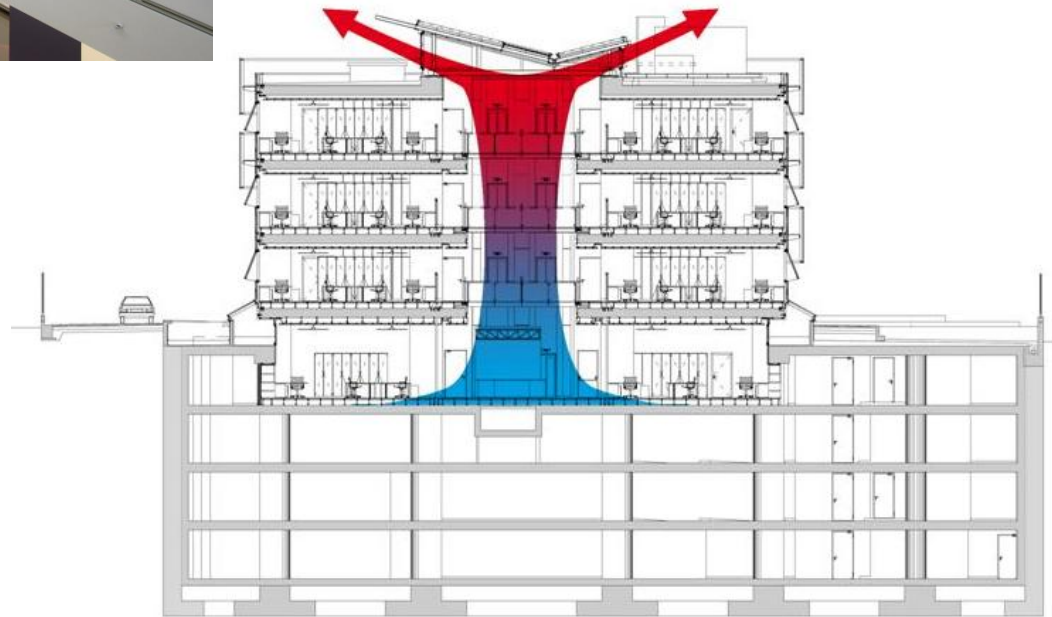

ΦΑΙΝΟΜΕΝΟ ΚΑΜΙΝΑΔΑΣ

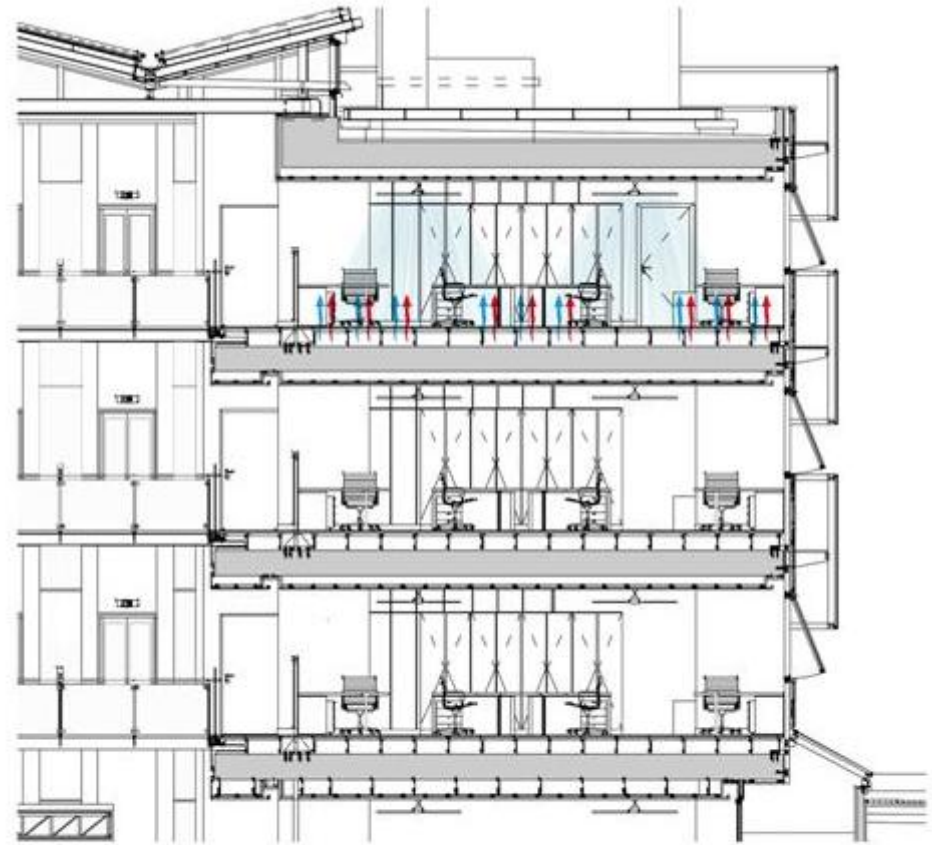

ΑΝΕΜΙΣΤΗΡΕΣ ΟΡΟΦΗΣ  
ΥΠΕΡΥΨΩΜΕΝΟ ΠΑΤΩΜΑ





ALPHA BANK



**Navarino Dunes, Μεσσηνία (2010)**









Τη προσαρμογή στη φυσική τοπογραφία και τις κλίσεις του εδάφους

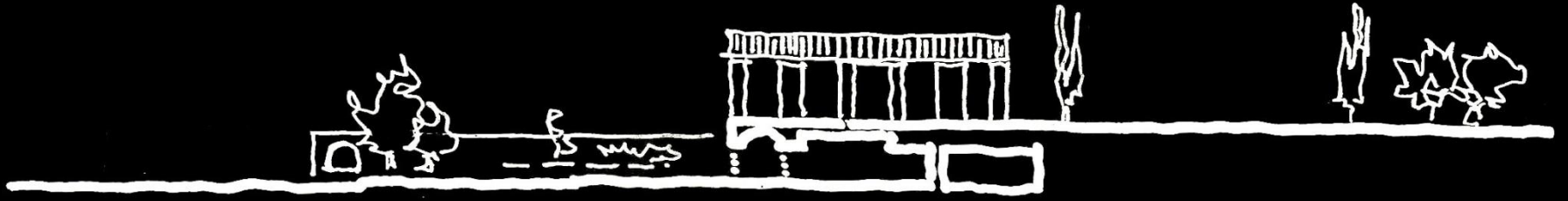

Τη διάσπαση και κλιμάκωση των όγκων ώστε να δοθεί στο σύνολο ανθρώπινη κλίμακα παρά την εκτεταμένη του ανάπτυξη





Σε χαρακτηριστικές θέσεις εισάγονται στοιχεία μεγαλύτερου ύψους

η μέγιστη αξιοποίηση της θέας προς τη θάλασσα



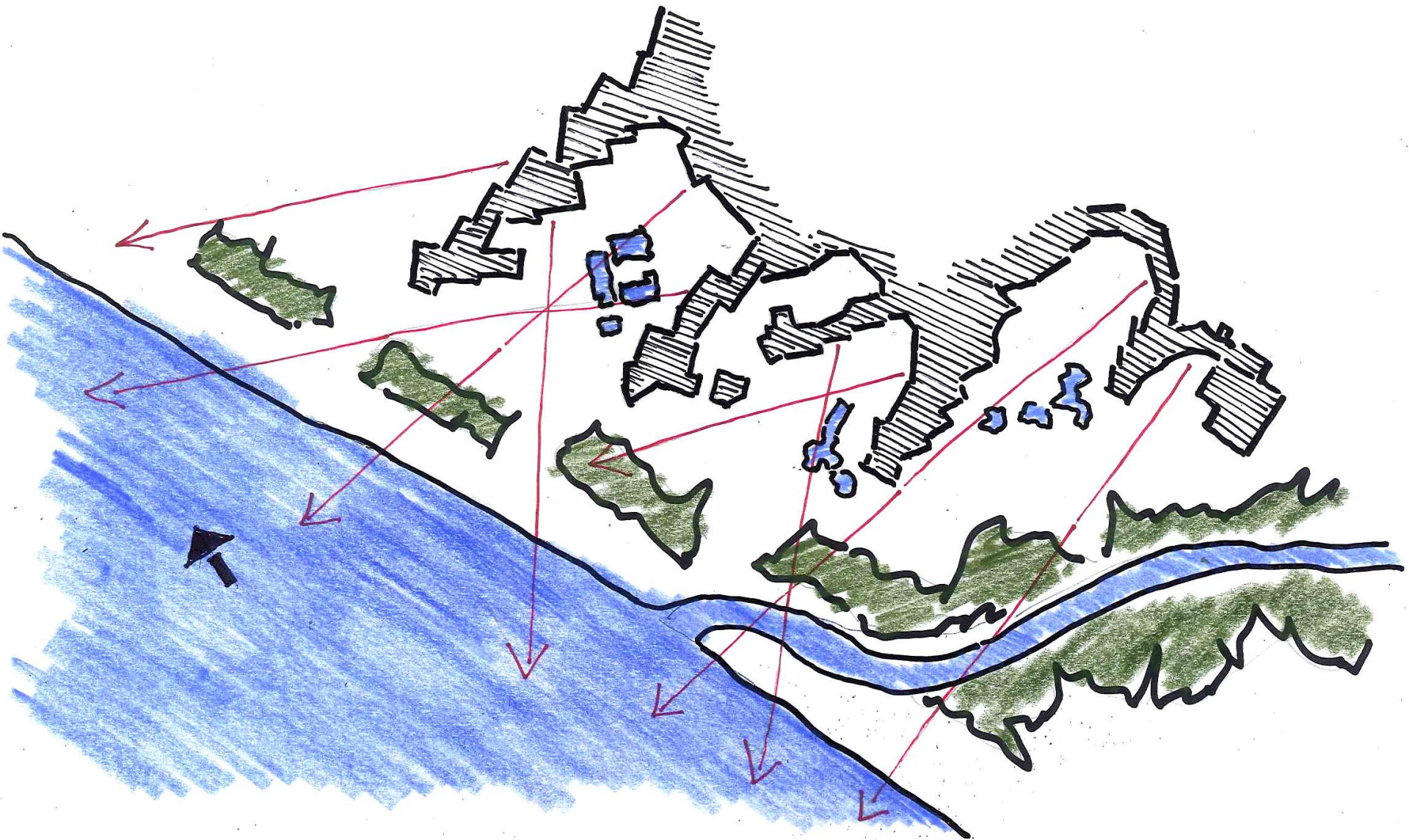



# Υπαίθροι διάδρομοι







Σωστή σκίαση των ανοιγμάτων



# Φυσικός φωτισμός



# Καλά θερμομονωμένο κτηριακό κέλυφος

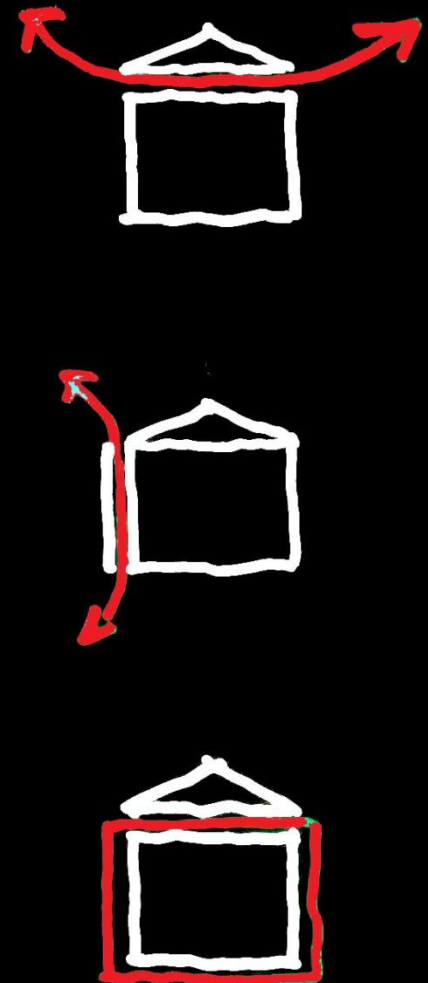

# Ελεύθερες στέγες

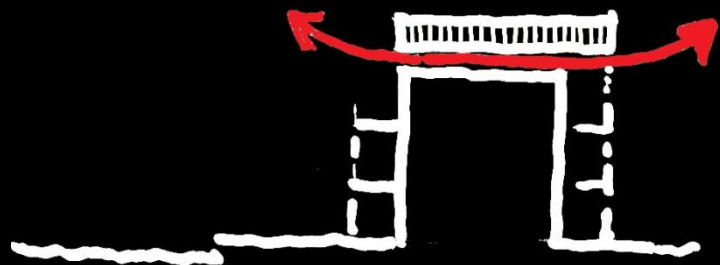

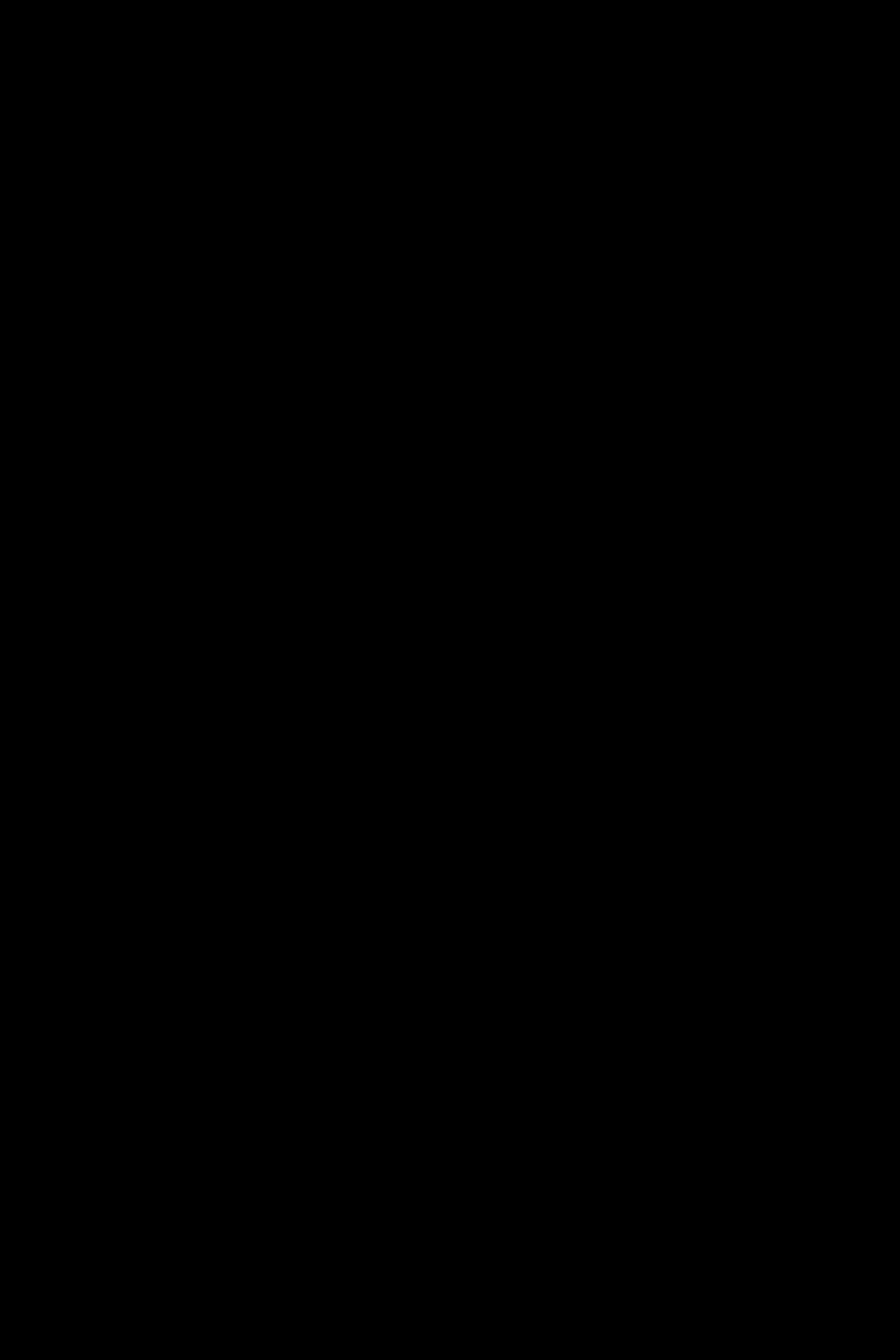



Αγορά







# Προσεκτική μελέτη του περιβάλλοντα χώρου





Η διαφύλαξη του υπάρχοντος πρασίνου  
και ο εμπλουτισμός με φύτευση στοιχείων  
της τοπικής χλωρίδας





Η μεγαλύτερη μεταφύτευση υπαρχόντων δέντρων στην Ευρώπη



Τουλάχιστον 16.000 ελιές  
Πάνω από 8.000 ξινά και άλλα δέντρα



Το ποσοστό επιτυχίας μέχρι σήμερα προσεγγίζει το 100%



Επιπλέον φυτεύθηκαν 6.000 νέα δέντρα και  
200.000 ενδημικοί θάμνοι διαφόρων ειδών

5.000μ<sup>2</sup> φυτεμένα δώματα



Δροσισμός μέσω εξάτμισης







Την εφαρμογή λιτού αρχιτεκτονικού λεξιλογίου  
με αναφορές στην τοπική παραδοσιακή αρχιτεκτονική



Την εφαρμογή απλών και φυσικών υλικών  
πέτρα, σοβάς, ξύλο, κεραμίδι, βότσαλο

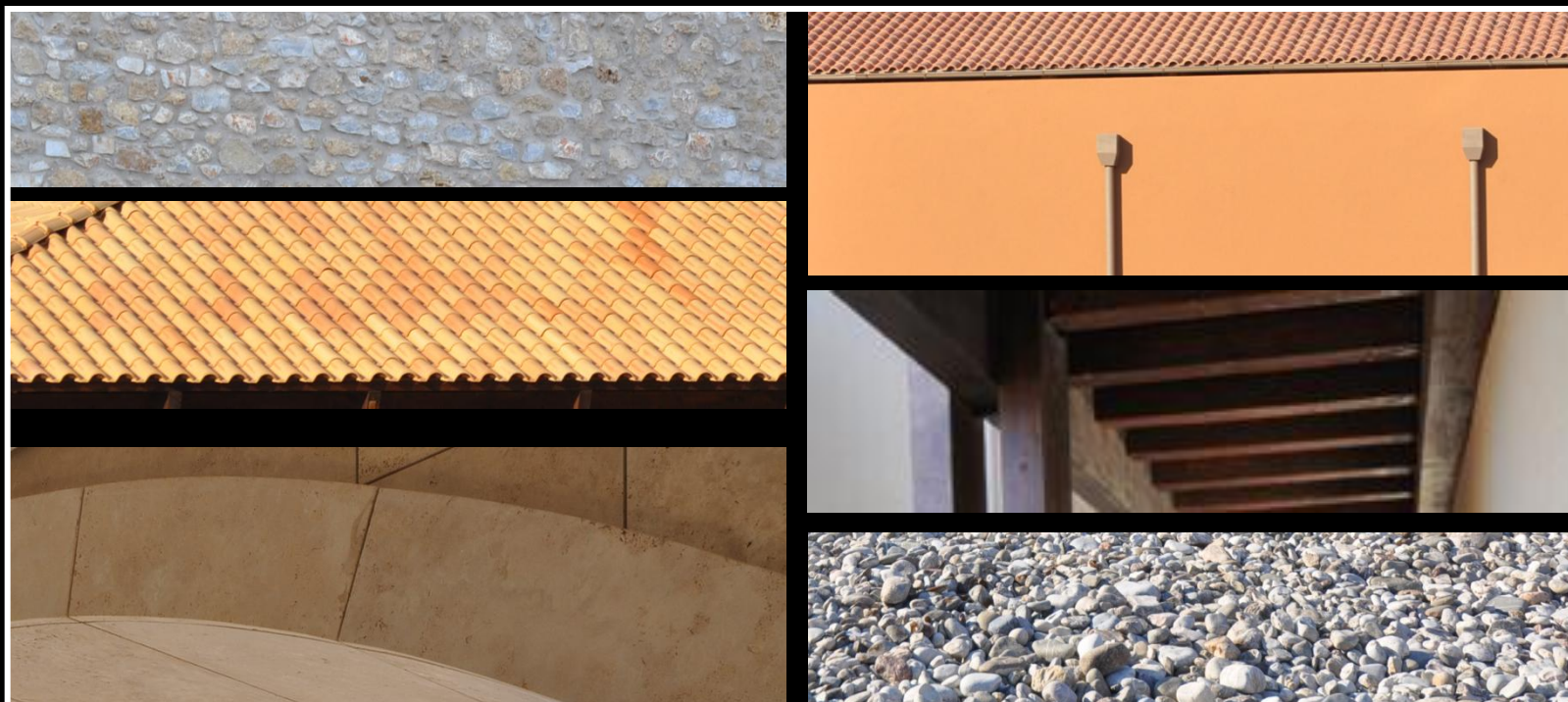

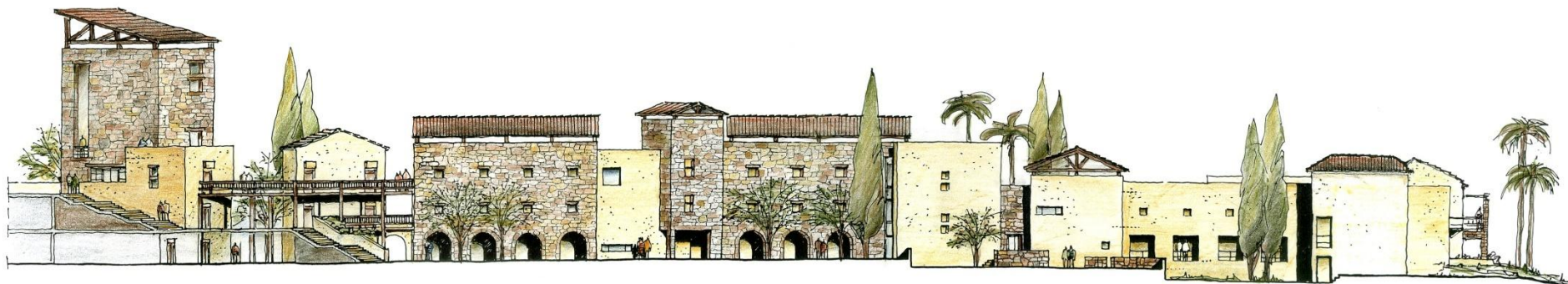



## Ενέργεια

Μείωση της ενεργειακής κατανάλωσης χρησιμοποιώντας σύστημα γεωθερμίας τοποθετημένο κάτω από το γήπεδο του γκολφ



## Ορθολογική διαχείριση νερού

Δύο αποθηκευτικές λιμνοδεξαμενές συνολικής χωρητικότητας 700.000 μ<sup>3</sup> περίπου, οι οποίες αξιοποιούν ελάχιστο ποσοστό από την πλεονάζουσα επιφανειακή απορροή των τοπικών ποταμών κατά τη χειμερινή περίοδο

Ανακύκλωση νερού με τη χρήση επεξεργασμένων λυμάτων για άρδευση των γηπέδων γκολφ και των χώρων πρασίνου

Δίκτυο μετεωρολογικών σταθμών, σταθμηγράφων και πιεζομέτρων για την παρακολούθηση των υπόγειων και επιφανειακών υδάτων





Το μέλλον



Για να **προβλέψεις** το μέλλον  
πρέπει να μάθεις από το **παρελθόν**





Business as usual?



Ελληνικό, Lamda Development, 2014



# Ενεργειακός σχεδιασμός κτηρίων και αρχιτεκτονική

Γιάννης Ρωμάνος, αρχιτέκτων  
Γραφείο Μελετών Αλέξανδρου Ν. Τομπάζη Α.Ε.

**Πανεπιστήμιο Πατρών**  
Σεμινάριο Βιοκλιματικού Σχεδιασμού Κτηρίων  
Τετάρτη, 25 Μαΐου 2016